

Since 1968

COMMAX
SmartHome & Security

User Manual

AUDIOGATE SECURITY STATION CDS-2AG



www.commax.com

COMMAX Co.,Ltd.



- Thank you for purchasing COMMAX products.
- Please carefully read this User's Guide (in particular, precautions for safety) before using a product and follow instructions to use a product exactly.
- The company is not responsible for any safety accidents caused by abnormal operation of the product.



Contents

1. Things to be aware before installation	1
2. Important Safeguards	2
3. Parts	4
4. Household unit call	7
5. To call a lobby phone	8
6. To page a household unit by Registered LP (License Plate) number	8
7. Broadcasting	9
8. "REJECT" function	9
9. "Away" mode and delay setting	9
10. In case of Emergency	10
11. To alert a delivery package (parcel).....	11
12.To check the communication status of a household	11
13. To set the time	12
14. Registration (Please review thoroughly).....	12
15. Built-in Program (Security Station).....	17
16. System Diagram	19
17. Wiring	20
18. Other information	21
19. Specification and Feature.....	21



1. Things to be aware before installation

- * CDS-2AG is to be connected with a lobby phone at the public entrance via 4 common wires with 1 channel / 2-wire voice communication, "Balanced Type".
- * CDS-2AG is expandable up to 4 stations by allocating an ID to each device.
- * Wiring must be reviewed thoroughly before installation to prevent any damage.









2. Important Safeguards

Please follow the things described below in order to prevent any danger or property damage.

 **Warning**
It may cause a serious damage or injury if violated.

 **Caution**
It may cause a minor damage or injury if violated.

-  Prohibition.
-  No disassembly
-  No touch
-  Must follow strictly.
-  Shows plugging out the power cord without an exception
-  Shows the warning and caution for an electric shock.
-  Shows the warning and caution for a fire.



Warning

Power & Installation

Please don't use several products at the same time on one power socket.

- It may cause a fire due to an abnormal overheating.







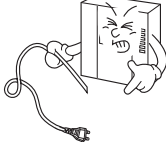

Prohibition Fire

Please don't bend the power cable excessively or it may cause an electric shock.

- fire when using a damaged power cable.





  

Prohibition Electric shock Fire

Please don't handle the power cable with a wet hand.

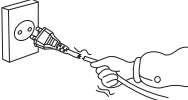
- It may cause an electric shock.





 

Prohibition Fire

Please plug out the power cable from the socket when not using it for a long period of time.

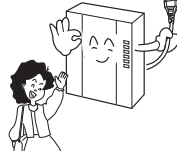
- It may shorten the product lifespan or cause a fire.







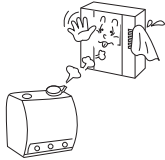

Request Fire

Please don't install the product in the place where there is much oil, smoke or humidity.

- It may cause an electric shock or fire.







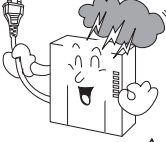

Prohibition Electric shock Fire

Please don't install the product with the lightning and thunder.

- It may cause an electric shock or fire.





  

Prohibition Electric shock Fire

Please don't use and connect this product with other products with different rated voltage

- It may cause a disorder or fire.





 

Prohibition Fire

When installing the product that generates heat, please install the product away from the wall (10cm) for the ventilation.

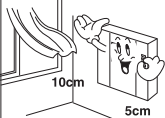
- It may cause a fire due to the increased internal temperature.



Prohibition Fire

! Warning

Cleaning & Use

Please don't disassemble, repair or rebuild this product arbitrarily (please contact the service center if a repair is needed).

- It may cause an electric shock or fire.

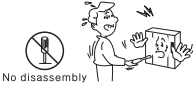

No disassembly



Electric shock



Fire



Unplug

If an abnormal sound, burning smell or smoke is coming out of the product, please plug out the power cable and contact a service center.

- It may cause an electric shock or fire.



Electric shock



Fire

Please don't insert any metallic or burnable materials into the ventilation hole.

- It may cause an electric shock or fire.

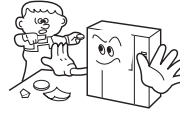

Prohibition



Electric shock



Fire

Please use only the designated batteries for the products of using DC power.

- It may cause an electric shock or fire.



Request

! Caution

Power & Installation

Please plug the power cable firmly into the inner end

- It may cause a fire.

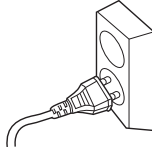

Request



Fire

Please hold the plug tightly when unplugging the power cable (a part of the copper wire may be disconnected if the grabbing is only made on the cord when pulling out the cable).

- It may cause an electric shock or fire



Request



Electric shock



Fire

When connecting the power cables after cutting the cable, please install the product with power off

- It may cause an electric shock or fire



Request



Electric shock



Fire

When installing the product, please fix it firmly while using the wall-mounting unit and screws.

- It may cause an injury from the falling object.

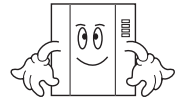

Request

Please be careful when using an AC circuit breaker since there is a possibility of an electric shock.

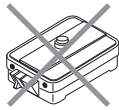

Request



Electric shock

Please check the use voltage and current for the DC-only products and use the appropriate rectifier.

- It may cause a fire.



Request



Fire

Please avoid direct rays of the sun or heating devices at a time of installation.

- It may cause a fire.



Request



Overheating



Fire

Please don't install the product on an unstable place or small support board.

- It may cause an injury if it falls down while in use.



Request

Cleaning & Use

When cleaning the product, please rub it with a soft and dry cloth after plugging out the power cable. (Please don't use any chemical products such as wax, benzene, alcohol or cleanser.)



Prohibition

Please don't drop the product on the ground and don't apply a shock.

- It may cause a failure.

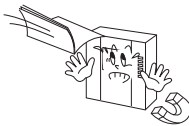

Prohibition

Please use the designated connection cable within the maximum calling distance designated for the product

- It may reduce the product performance.



Request



3. Parts names

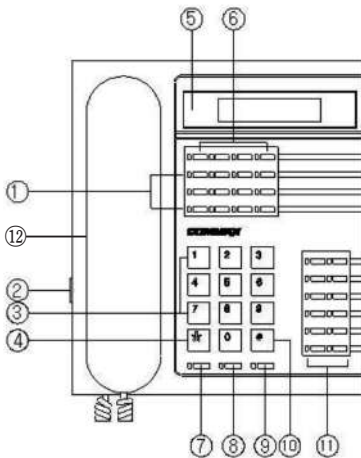

No.	Item	No.	Item
1	Set up and input button	7	Broadcasting button
2	Paging volume control switch	8	Call operating button
3	10-key button	9	Speakerphone button
4	Building button	10	Paging button
5	LCD	11	Speed dial input and set up button
6	Call waiting button (1~4)	12	Hand set

Button details

①, ⑥ Buttons

- 1) "SELECT 1~4" button : check a missed call
- 2) "TIMER" button : to set up time
- 3) "PROGRAM" button : to input security station program set up
- 4) "PROGRAM CHECK" button : to change security station program set up
- 5) "REJECT" button : to forward a call to other security station
(Number for call forwarding security station must be registered via "Pr03")
- 6) "AWAY MODE" button : to set up "away" mode of any household units
- 7) "REMOTE CONTROL" button : to confirm and/or change household unit information
- 8) "◀, ▶" button : to confirm and/or change input data
- 9) "EXPANSION" button : to input a multi-sub number for a household unit or other expansions.
- 10) "REDIAL" button : to call a last call
- 11) "EMERGENCY CALL" button : to check and page a household unit with emergency paging
- 12) "DOOR RELEASE" button : to release a public entrance lock

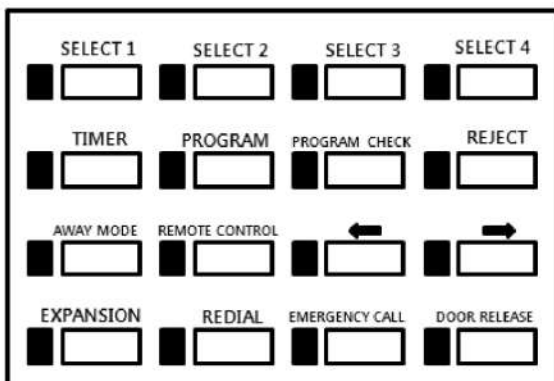

③, ④, ⑦, ⑧, ⑨, ⑩ Buttons

- 1) 10 key buttons : to dial numbers
- 2) Building button(*) : to input building number
- 3) Paging button(#) : right after entering a household unit number
- 4) Broadcasting button : Broadcasting among security stations
- 5) Call operating button : Forwarding a call from a unit to another unit/security station
- 6) Speakerphone button : Speakerphone function

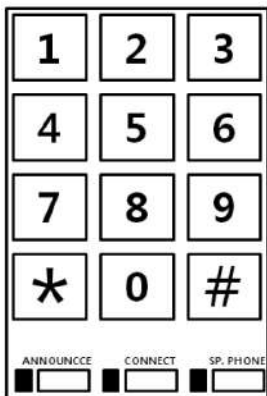

⑪ Speed dial button

- 1) Speed dial button (1~8) : For frequently used numbers
- 2) Extension call 1 lamp (LED) : Indicating extension call line 1
- 3) Confirm button: Identifying a unit by license plate number
- 4) Parcel/LP (License Plate) button : Paging a unit by LP number
- 5) Input1, Input2 : To enter LP number

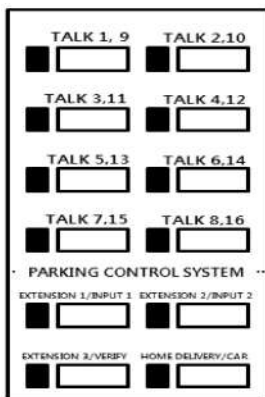

※ **Caution**

- 1) Please place a handset on the hook.
(If it is placed unhooked, all calls and pages will not be received)
- 2) When unit numbers are being registered at the lobby phone, this security station device must be off.
- 3) Some of the above functions are disabled depending on the security station device.



4. Household unit call

Paging a security station from a household unit

- 1) When paging a security station from a household unit, the household unit number will be displayed on the LCD on the security station and the security station rings.
- 2) Pick up the handset to talk.

To page a household unit

- 1) Pick up a handset and dial the number of household unit
(Press 9999 to page another security station).
- 2) Press “*” (Building button) key
(the number on the display will change to building location)
- 3) Dial the household unit number
(to page another security station, enter the ID number of the security station).
- 4) Press “#” (Paging button) to page (paging sound will ring).
- 5) Talk as the household unit answers (when line is busy, please try again later).

To call units who call during guard absence

- 1) “Select 1~4” button’s lamps turn on when units call during guard absence.
- 2) Household unit number is displayed on the LCD to press “Select” button
- 3) Press “#” (Paging button) key.
- 4) Talk as the household unit answers

To connect a unit-to-unit call

※ **Caution**

If the call is made from a security station, the operator function will not be functional.

- 1) While talking to a unit, if the call is made from the unit to security station, press the “Call operating” button (the lamp turns on).
- 2) Dial the building number and press “*”.

- 3) Dial the household unit number and press “#” to connect a unit-to-unit call (double tone sounds, lamp turns off, and “Exchange OK...” is displayed on the LCD).

※ **Reference**

If the number is mis-pressed, please use “◀” button to correct.

- 4) Place the handset on the hook.



5. To call a lobby phone

To page a security station from a lobby phone

- 1) When a security station is paged from a lobby phone, the bell rings and the number of lobby phone will be displayed on the LCD.
- 2) Pick up the handset to talk.
- 3) Press “Release” button to open the gate while connected.

To call a lobby phone from a security station

- 1) Pick up a handset and dial a lobby phone number.
- 2) Press “#”(Paging button) key.
- 3) Listen to the calling tone and start talking to a visitor.
- 4) Press “Release”button to open the gate while connected.

To open the gate at the public entrance

- 1) Pick up a handset and enter the building number and press “*” (Building button) key.
- 2) Enter a lobby phone number/ID and press “#”(Paging button) key.
- 3) Listen to the paging tone and press “Release” button to open the gate.
- 4) Hang up to complete the transaction.



6. To page a household unit by Registered LP (License Plate) number

※ **The above function is only functional**

if LP numbers are pre-registered with the unit numbers.

※ **The functions about LP are not able to use if household unit is not support it.**

- 1) Pick up a handset and press “LP”button.
(LCD displays “car > - “)
- 2) Enter LP number and press “*” (Building button) and then, press “#”(Paging button) to page the household unit that is pre-registered with the LP number.



7. Broadcasting

- 1) Pick up a handset and press “Broadcasting” button (Ref. Page 6).
- 2) Make an announcement.



8. “REJECT” function

※ Remarks

- This function is useful when security guards are out of office.
(Only functional as the “Program 02” is set up)
- If the security station power is turned off and back on, “REJECT” function is disabled.

- 1) Press “Forwarding” button
- 2) The lamp is on to indicate the “REJECT” function is on.
- 3) To disable “Forwarding”, press “Forwarding” button once again
(By picking up a handset or pressing “Speakerphone” button, call forwarding function is disabled).



9. “Away” mode and delay setting

※ This is only functional as household unit phones have “Away” mode available.

- ※ As a security station sets a designated unit as “Away”, the household unit is set to “Away” mode.

(If the household has its door with sensor left open, “Away” mode cannot be armed)

- ※ Away mode delay means a time delay before getting into security alert as the resident enters home.

To set a household unit as “Away” mode from a security station

- 1) Press “Away” button on the security station.
(Away button and Speakerphone LED are turned on)
- 2) Enter the building number and press “*” (Building button) and press “#” (Paging button).
- 3) “Away Consent ok” is displayed on the LCD.
- 4) If the household has its door with sensor left open, “Away Err Reject” message is displayed.
- 5) Press “Speakerphone” button to complete the transaction.

To check the household unit's "Away" status

- 1) Pick up a handset or press "Speakerphone" button.
- 2) Enter the building number + "*" key and enter the household unit number and then, "Paging" button.
- 3) If the household is set to "Away" mode, "OUT" message is displayed on the LCD.
- 4) Place a handset back on a hook.

To set a delay time of "Away" mode

- 1) Press "Remote" button (Ref. Page 7).
- 2) Enter the building number + "*" key and enter the household unit number and then, press "Away" button.
- 3) As "Away" mode delay is set, "Sensor Chk Wait" is displayed on the LCD.
- 4) Press "Speakerphone" button to complete the transaction.
- 5) For 10 minutes from the time "Away mode delay" input, the security alert is not activated (even if the door is opened).



10. In case of Emergency

※ This is functional if the household units have "Away" mode available.

As a security alarm sounds by sensors

- 1) All security stations connected are alerted.
- 2) The connected sirens go off and the number of building and household unit is displayed on the LCD.
- 3) The alert is on until any of the security stations connected to the system pages and calls the household unit.

Emergency alert method

- 1) Pick up a handset or press "Speakerphone" button and press "Emergency" button.
(the priority is given to the higher floor)
- 2) The household unit number with sensor detection occurred is displayed on the LCD.
- 3) Emergency alarm of household is ringing.
- 4) To stop the alert, place the handset back on a hook.



11. To alert a delivery package (parcel)

※ **This is function if the household units have “Parcel display” mode available.**

To alert a delivery package from station to household unit

- 1) Press “Speakerphone” button.
- 2) Enter the building number + “*” key + household unit number.
- 3) Press “Parcel” button.
(display “Delivery” message on the LCD of household or the power lamp is blinking.)
- 4) Press “Speakerphone” button to finish the transaction.

When household get a parcel without a call to station

※ **If you do not check an parcel alarm of a household unit, it might be remained an alarm on unit’s LCD.
In this situation, clear it from station.**

- 1) Press “Speakerphone” button.
- 2) Press “Parcel” button.
- 3) Enter the building number + “*” key + household unit number.
- 4) Press “Parcel” button
(Clear an alarm in household unit)
- 5) Press “Speakerphone” button to finish the transaction.



12. To check the communication status of a household

To check the communication line status of a single household unit after installation

- 1) Press “Remote” button (“Rmot > - “ is displayed on the LCD).
- 2) Enter the building number + “*”key and enter the household unit number and then press “#” key.
- 3) The status is displayed on the LCD.

To check the communication line status of a whole building

※ **Remarks**

This function is used to check the line status of all household units in a building.

If sub units are installed in a single household unit, this function checks only the master device.

- 1) Press “Remote” button.

- 2) Enter the building number that you wish to check + "*" (Building button) and enter the lowest household unit number.
- 3) Press "Extension" button.
- 4) Press "Confirm" button
- 5) Enter the highest household unit number (*do not enter the building number again).
- 6) Press "#" (Paging button). The system starts checking the line status (If error occurs, it will be displayed on the LCD and the status checking process stops)
- 7) Press "#" (Paging button) to continue checking the status.



13. To set the time

※ **When you set up the time, please do not pick up a handset.**

- 1) Press "Time" button.
- 2) Please enter YY(year) – MM(month) – DD(date) – HH(hour) – MM(minute) – W(day) in this order (*24 hours standard).
 - ※ Day : 1(for Sunday) ~ 7(for Saturday)
 - ※ (Ex : 99 (year)10 (month) 11 (date) 09 (hour) 30(minute) Tuesday → Please enter as 99 10 11 09 30 3
- 3) Press "Input".



14. Registration (Please review thoroughly)

To register each household unit number

※ the unit number registration only functional as the household unit calls the security station and during the call.

Please do not hang up while registration is being processed.

(Registration does not work if the call was initiated by the security station)

- 1) Pick up a handset of the household unit phone and call a security station.
- 2) Please pick up the handset (security station) & press "Remote" button.
- 3) Enter the building number and press "*" (Building button).
- 4) Enter the household unit number and press "Extension" button.
 - ※ If "#" (Paging button) was pressed instead of "Extension" button, it will be recognized as the master unit.
- 5) Enter a sub unit number (from 0 to 9) and press "#" (Paging button).

- ※ If a sub unit is not installed, just press “#”(Paging button).
- 6) Press “#”(Paging button) and hang up to complete the registration.

To register LP (License Plate) number for a household unit (for a parking control)

- ※ 2 LP numbers are allowed to register per each household unit.

If a LP number for a household is already known

- 1) Press “Speakerphone” button.
- 2) Enter the building number + “*”key and enter the household unit number and then, press “Input 1” or “Input 2” button.
(display “Car1 xx-xxxx” or “Car2 xx-xxxx”on LCD)
- 3) Enter the LP number.
- 4) To correct the entered LP number press (◀ or ▶).
- 5) press “Input 1” or “Input 2” button.
- 6) To complete the registration. After save LP number data

Registering LP number when a household unit calls the security station

※ Caution

If the call is made from a security station, the operator function will not be functional.

- 1) Pick up a handset as paged by a household unit and press “Remote” button.
- 2) Enter the designated parking lot number + “*”key and enter the LP number.
- 3) To correct the entered LP number press (◀, ▶) to make corrections.
- 4) Press “Input 1” or “Input 2”to store the LP number.
- 5) Place a handset back on a hook to complete the registration.

To indicate a household unit number by LP number

- 1) Press “Speakerphone” button.
- 2) Press “Confirm” button located at the Speed dial buttons (Ref. Page 8).
(“car > - “ is displayed on the LCD)
- 3) Enter the LP number and then press “#”(Paging button).
- 4) The household unit number is displayed on the LCD.

To manage unit numbers at Floor Distributors (CCU-204AG/232AG).

- ※ This function is enabled when Floor distributors are installed.
- ※ While conducting this function on the Floor distributor, the lobby phone connected to the Floor Distributor does not work.

To upload household unit numbers

- ※ Uploading household numbers to the Floor Distributor is enabled via security station.
- 1) Connect a PC to the RS-232 port of security station.
 - 2) Execute a program provided by COMMAX and input data of household unit number.
 - 3) Execute the program number 06 at the security station to turn on the data receiving mode.
 - 4) As you send the data from the PC, the household unit number data is updated at the Floor Distributor via security station.

To download household unit numbers

- ※ Downloading household numbers from the Floor Distributor is enabled via security station.
- 1) Connect a PC to the RS-232 port of security station.
 - 2) Execute a program provided by COMMAX.
 - 3) Execute the program number 05 at the security station to turn on the data receiving mode.
 - 4) Enter "9700" in the Building number section and press "*" (Building button).
 - 5) Enter the ID of the Floor Distributor and press "#" (Paging button) to start downloading household unit number data.
- ※ PC must be connected to the security station via RS232 port.
If not, downloading process will be at standing-by mode.
- 6) Data can be revised in the PC program.

Tip) To change the unit number data without a PC after downloading

- 1) After uploading the household unit number data from the Floor Distributor via a security station, use (◀ or ▶) buttons to select the data to be changed.
- 2) After selecting the household unit number to change, press "Input" button.
- 3) As cursor appears, use (◀ or ▶) buttons to change the data.
 - Building number, Household number, Password and Sub
 - Number (Refer to below "Setting specific functions")

- 4) After change is made, press “Remote” button.
- 5) downloading the revised data to the Floor Distributor starts

[Refer] Setting specific functions.

1) Setting the function of DTMF

- ※ It’s able to set when audio floor distributors with DTMF function are installed. (ex. CCU-232AGF)
 - ※ You can use the keypad to call the guard(or other household unit) or open the door if household unit device is phone with keypad.
- 1) After downloading the household unit number data from the Floor Distributor via a security station, use (◀ or ▶) buttons to select the unit what use the function of DTMF.
 - 2) Change the Sub-Number to '1'(Number one)

Terminal	01	01
0101-0001	1234	01

①
②
③
④

① Port ID

② Building Number – Household Number

③ Password

④ Sub-Number

- 3) You can use the keypad to call or open.

**2) Setting the monitoring lobby ID
(Above CDS-2AG Program Version 2.0)**

- ※ It’s able to set when video floor distributors are installed.
- 1) After downloading the household unit number data from the Floor Distributor via a security station, use (◀ or ▶) buttons to select the unit what you want to change the monitoring lobby.
 - 2) change the Sub-Number to ‘Lobby ID what you want to monitor’
ex) 1(Number one)

Terminal	01	01
0101-0001	1234	

①
②
③
④

① Port ID

② Sub-Number(Monitoring Lobby ID)

③ Building Number – Household Number

④ Password

- Sub-Number ‘0’ : The function of DTMF is disabled.

- Sub-Number ‘1’ : The function of DTMF is enabled.

- 3) You can monitor through the lobby phone ID 1.

To manage household unit data at a lobby phone

- ※ This function is enabled only if the lobby phone has name storing function available.
- ※ While conducting this function, the lobby phone is not functional.

To upload the name information

※ Uploading data is enabled via a security station.

- 1) Connect a PC to the RS-232 port of security station.
- 2) Execute a name information input program and enter data
- 3) Execute the program number 06 at the security station to turn on the data receiving mode.
- 4) As you send the data from the PC, the name information data is updated at the lobby phone via security station.

To download the name information

※ Downloading data is enabled via a security station.

- 1) Connect a PC to the RS-232 port of security station.
 - 2) Execute a name information input program.
 - 3) Execute the program number 05 at the security station to turn on the data receiving mode.
 - 4) Enter the building number and press "*" (Building button).
 - 5) Enter the ID of the lobby phone and press "#" (Paging button) to start downloading the name information data.
- ※ PC must be connected to the security station via RS232 port.
If not, uploading process will be at standing-by mode.
- 6) Data can be revised in the PC program.
- ※ The name information cannot be changed at the security station.



15. Built-in Program (Security Station)

- 1) Press “Confirm” button.
 (“Password – “ is displayed on the LCD)
- 2) Enter “9999” and press “Input” button.
 (“Program – “ is displayed on the LCD)
- 3) Use (◀ or ▶) buttons to select Program (Ref. [Chart 1])
- 4) Enter data and press “Input” button.
- 5) Press “Speakerphone” button to complete.

※ Remarks

Program 00 is used for an initial setting of security station and shall not be amended.

If changed with wrong data, the connection can be lost.

[Chart 1] Program number and content

Program Number	Content	Data selection
Pr [00]	Device ID set up : Set up Security Stations ID	From 0001 to 9000
Pr [01]	Sub Building number set up : Preset the building number → input a household unit number to make a call without entering the building number	Building number
Pr [02]	Call forwarding security station number set up	Building number + unit number
Pr [03]	Name information data upload from a lobby phone	Receiving mode
Pr [04]	Name information data download to a lobby phone	Sending mode
Pr [05]	Household unit information data upload from a Floor dist.	Receiving mode
Pr [06]	Household unit information data download to a Floor dist.	Sending mode
Pr [07]	Speed dial 1	Building number + unit number
Pr [08]	Speed dial 2	Building number + unit number
Pr [09]	Speed dial 3	Building number + unit number
Pr [10]	Speed dial 4	Building number + unit number

Program Number	Content	Data selection
Pr [11]	Speed dial 5	Building number + unit number
Pr [12]	Speed dial 6	Building number + unit number
Pr [13]	Speed dial 7	Building number + unit number
Pr [14]	Speed dial 8	Building number + unit number
Pr [15]	Sub	
Pr [16]	Sub	
Pr [17]	Sub	
Pr [18]	Sub	
Pr [19]	Sub	
Pr [20]	Sub	
Pr [21]	Sub	
Pr [22]	Sub	
Pr [23]	Sub	
Pr [24]	Sub	
Pr [25]	Sub	
Pr [26]	Sub	
Pr [27]	Sub	
Pr [28]	Sub	
Pr [29]	Sub	
Pr [30]	<p>Master and sub device set up :</p> <p>Only 1 device to be set up as master.</p> <p>Master plays a role in response to household requests that have to need to response by Guard Unit like emergency mode, away mode and so on.</p>	<p>1 : Master</p> <p>0 : Sub</p>



16. System Diagram

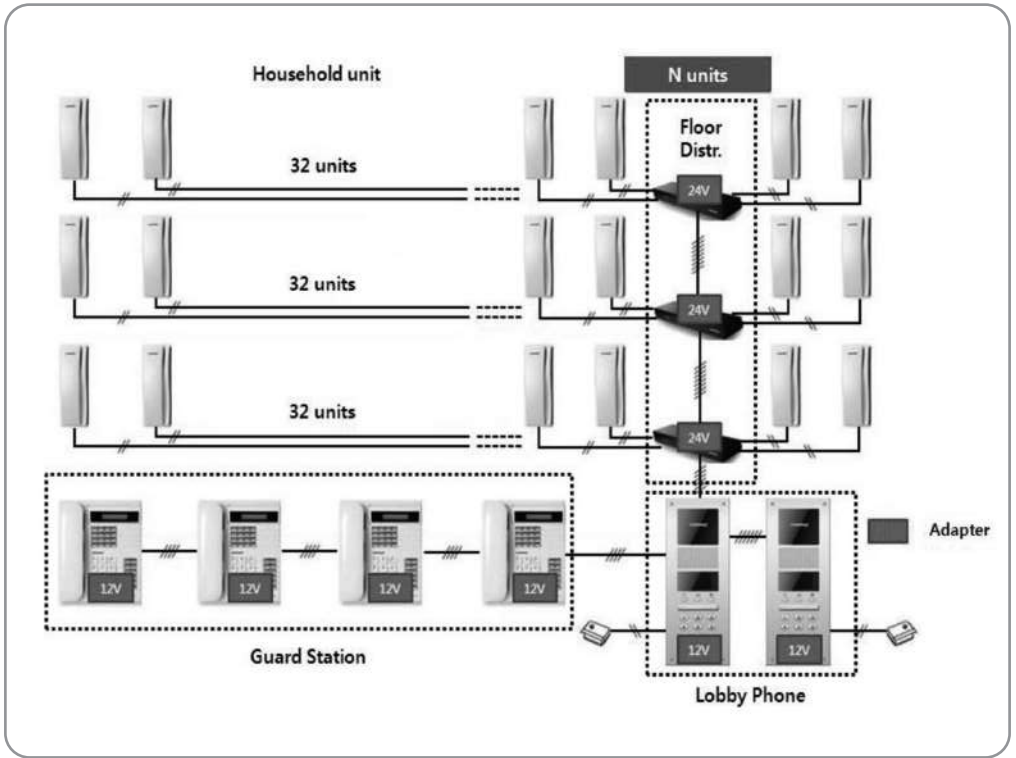



17. Wiring

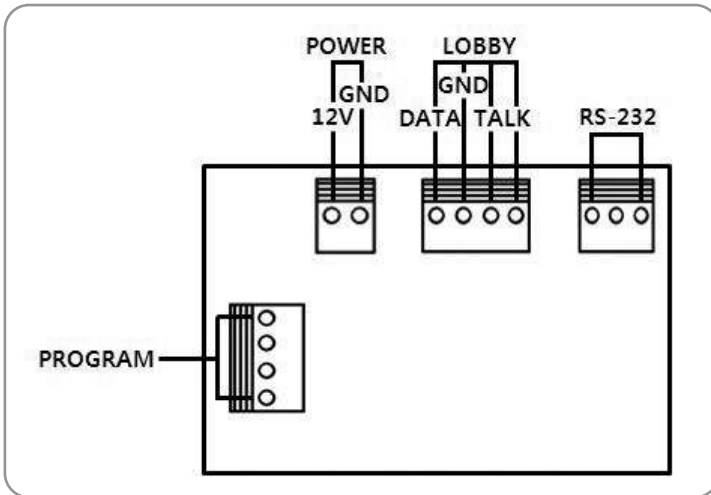

※ If more than 2 security stations are installed, 4 common wires required. [Refer to below diagram]

- Each device ID set up required
- If more than 3 security stations are installed and a combination of CDS-4GS & CDS-2AG are in use, CDS-4GS must be set up as Master (ID: 01) and Slave 1 (ID: 02). Therefore the ID for CDS-2AG should be set up from 03.

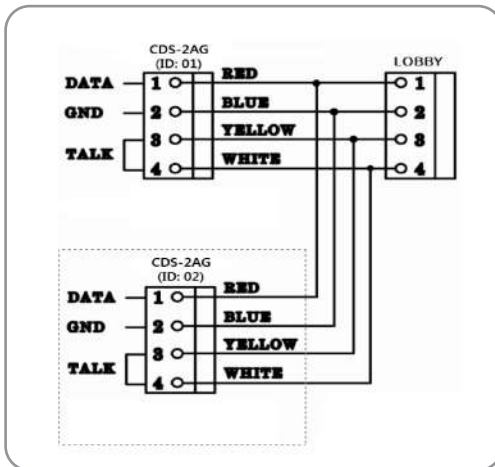



18. Other information

- ※ Before making a call for a faulty equipment, please read the manual thoroughly.
- ※ Please check all status prior to making a customer service call.



19. Specification and Feature

Model	CDS-2AG
Wiring	4 Common Wires
Power	12V $\overline{=}$
Power Consumption	Standby : 70mA Maximum : 120mA
Communication	Simultaneous Communication Method
Ring tone	Mono tone
Range	100 meter / $\varnothing \pm 0.65\text{mm}$ wire (Distance to lobby phone)

COMMAX

COMMAX Co.,Ltd.

513-11, Sangdaewon-dong, Jungwon-gu, Seongnam-si, Gyeonggi-do, Korea

Int'l Business Dept. Tel. : +82-31-7393-540~550 Fax. : +82-31-745-2133

Web site : www.commax.com

PM042AG00010

Printed In Korea / 2014.10.104