

iWISE™

Models: RK815DTGL
RK825DTGL



© RISCO Group 05/2015 5IN1258 F



U.S. Patent Number:
This product is protected under Patent No. US 7,126,476 B2. Other patents pending.

RTTE Compliance Statement:
Hereby, RISCO Group declares that this equipment is in compliance with the essential requirements and other relevant provisions of Directive 1999/5/EC For the CE Declaration of Conformity please refer to our website: www.riscogroup.com.

EN50131-1 Grade 2
EN50131-2-4 Grade 2
EN50130-5 Class II
EN50130-4



RK815DTGL/RK825DTGL applicable countries (European version):

AT	BE	CY	CZ	DK
EE	FI	FR	DE	GR
HU	IE	IT	LV	LT
LU	MT	NL	PL	PT
SE	SL	ES	SK	GB
BG	RO	TR	CH	NO

RK815DTGL/RK825DTGL applicable countries (German Version): AT, CZ, SL, DE, TR, RU, EE

iWISE 810DTGL/815DTGL/825DTGL FCC compliance Section (US version):

FCC Part 15 Note:
This equipment has been tested and found to comply with the limits for a Class B digital device, pursuant to Part 15 of the FCC rules. These limits are designed to provide reasonable protection against harmful interference in a residential installation. This equipment generates, uses and can radiate radio frequency energy and, if not installed and used in accordance with the instructions, may cause harmful interference to radio communications.

However, there is no guarantee that interference will not occur in a particular installation. If this equipment does cause harmful interference to radio or television reception, which can be determined by turning the equipment off and on, the user is encouraged to try to correct the interference by one or more of the following measures:

- Reorient or relocate the receiving antenna.
- Increase the separation between the equipment and receiver.
- Connect the equipment to an outlet on a circuit different from that to which the receiver is connected.
- Consult the dealer or an experienced radio/TV technician.

FCC Warning:
The manufacturer is not responsible for any radio or TV interference caused by unauthorized modifications to this equipment. Such modifications could void the user's authority to operate the equipment. FCC ID: JE4CSMDT

UL Compliance Section:
This product is UL639 listed for Residential and Commercial intrusion detectors. To comply with UL, note the following:
♦ The units are intended to be connected to a Listed control unit or Burglar alarm power supply with power limited outputs with a voltage range between 9-16vdc that provides a minimum of four hours standby.
♦ The unit relays are to be connected to resistive loads only.
♦ Walk test should be performed once a year by an installer.
♦ For indoor use only.
♦ The range was verified by UL with the MW sensitivity set to Max.

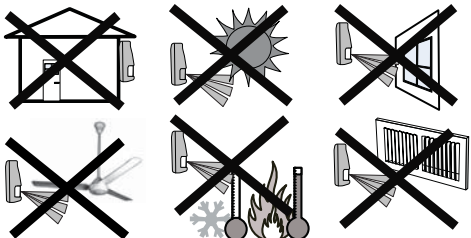

ENGLISH

iWISE RK815DTGL/RK825DTGL detectors are the ultimate motion detectors for professional installations, incorporating Anti-Cloak™ Technology (ACT™), adhering to new environmentally friendly guidelines. RK815DTGL/RK825DTGL detectors are available in 10m, 15m and 25m models, and include built-in end-of-line (EOL) resistors to simplify installation.

Installation / Maintenance

1. Mounting - The RK815DTGL/RK825DTGL can be mounted either on a flat surface or on a wall corner (corner mounting).
 - Using a suitable tool, open the following knockouts on the detector's base (see Figure 1).

Note: Back tamper "Breakable plate" not applicable in this version.

2. To select the correct vertical adjustment position for wide angle lens, use the scale on the bottom left hand side of the PCB as follows:

Mounting height and scale position based on room size:

Mounting Height	L - LONG	S - SHORT
For RK815DTGL		
2.1m-2.7m (6'11"-8'10")	15m (50')	6m (20')
For RK825DTGL		
1.8m-2.0m (5'11"-6'7")	25m (82')	8m (26')

Note: For Corridor installations, select position to "L" and mount the detector at 2.5m/8'2" height.

3. Set jumpers (see Jumper Setting section).

Note: Reset the detector after each change made to the settings.

4. Install the front cover back to its place (in a reverse sequence of the removal).
5. Perform a Walk test (see Walk Test section).
6. **Changing Lenses** (see Figure 2).

Terminal Wiring (Figure 5)

Terminal	Description
- 12 +	12VDC Input
ALARM	N.C. Relay
TAMPER	N.C. Tamper switch
FAULT/AM	Not applicable in this version.
LED	LED operation remote control
	When an "Activation Signal"*** is applied to the LED input terminal, all LEDs will be disabled.
	LEDs are enabled if nothing is connected (unless LED jumper is OFF) or 0V/12V is applied (according to the LED/SET Input Jumper position, 12V or 0V).

**Activation Signal-

If 12VDC is applied, and the LED/SET Input Jumper is on 12V position - Or -

0V is applied and LED/SET Input Jumper is on 0V position

Jumper Settings

Jumper	Function
SW1-1: LED	Used to determine the operation of the detector's LEDs
ON (Default)	LEDs are enabled, allowing LED control via the LED input terminal.
OFF	LEDs are disabled
SW1-2: ACT	Used to determine if ACT mode is enabled or disabled
ON	ACT Enabled Important: Do not use ACT™ mode if you are expecting that there will be moving objects outside the required protected area, a corridor for example.
OFF (Default)	ACT Disabled.

SW1-3: Green Line

The RK815DTGL/RK825DTGL includes a Green Line feature that follows environmental guidelines by avoiding surplus emission.

ON	Green Line feature is enabled: To deactivate the MW module, the LEDs must be remotely disabled by the LED terminal. Note: When 'Green Line' is on (Microwave off), the detector will still activate (PIR only)
OFF (Default)	Green Line feature in disabled: MW is constantly in use.
SW1-4: Self Test	Not applicable in this version.

J1 - Alarm EOL
J2 - Tamper EOL
Jumpers J1 and J2 allow the selection of Tamper and Alarm resistance (1K, 2.2K, 4.7K, 5.6K, 6.8K) according to the control panel (see Figure 3).
Follow the terminal block connection diagram in Figure 3 when connecting the detector to a Double End Of Line (DEOL) Zone.

J4 - LED/SET INPUT	Used to determine the polarity of the external input.
	See Terminal Wiring section, LED Terminal

Jumper	Function
	See Terminal Wiring section, LED Terminal

Walk Test

1. Two minutes after applying power (warm-up period), walk test the Detector over the entire protected area to verify proper operation of the unit (see Figure 6).
2. The MW range can be adjusted by using the potentiometer located on the PCB. It is important to set the potentiometer to the lowest possible setting that will still provide enough coverage for the inner boundary protected area (see Figure 4).

MW range adjustment (Figure 4)

1 Over power	A Detector
2 Under power	B Corridor
3 Correct adjustment	



LEDs Display

LED	State	Description
Yellow	On	PIR detection
	Flashing	Trouble in PIR channel
Green	On	MW detection
	Flashing	Trouble in MW channel
Red	On	ALARM
All LEDs	Flashing (consecutively)	At power-up, the LEDs will flash consecutively until the end of the warm-up period (2-3 minutes).

Technical Specification

Electrical	
Current consumption	16mA at 12VDC (Typical) 41mA at 12VDC (max.)
Voltage requirements	9 -16VDC***
Alarm contacts	24VDC, 0.1A
Tamper contacts	24VDC, 0.1A
Environmental	
RF immunity	According to EN50130-4
Operating temperature	0°C to 49°C (14°F to 131°F)
Storage temperature	-20°C to 60°C (-4°F to 140°F)
Optical	
Filtering	White Light Protection
Physical	
Size	127.6 x 64.2 x 46.6 mm (5 x 2.5 x 1.84 in.)
Weight	120 gr. (4.2 oz.)

*** Power to be supplied by 5A max. power source using safety approved wires, with a min Gauge of 20AWG.

FRANÇAIS

Les détecteurs iWISE RK815DTGL/RK825DTGL sont les tout derniers modèles de détecteurs de mouvement conçus pour établissements professionnels. Ils intègrent la technologie de l'Anti-Cloak™ (ACT™), répondant aux nouvelles directives de protection de l'environnement.

Disponibles en modèles 10m, 15m et 25m, les détecteurs iWISE RK815DTGL/RK825DTGL comprennent des résistances de Fin de ligne (EOL = end-of-line) intégrées qui facilitent l'installation.

Installation

1. Montage – RK815DTGL/RK825DTGL peut être installé soit sur une surface plane soit en coin (gauche ou droit).
 - A l'aide d'un outil adéquat, ouvrez les pastilles pré-percées correspondantes sur la base du détecteur (cf. Figure 1).

Remarque: Retour falsification "cassable plaque" pas applicable dans cette version.

2. Pour définir le bon réglage vertical, positionnez l'appareil en LENTILLE GRAND ANGLE. Servez-vous de l'échelle figurant sur le côté inférieur gauche de la carte PCB (cf. Figure 6) comme suit:

Hauteur de montage et position selon la taille de la pièce:

Hauteur de montage	L - LONG	C - COURT (SHORT)
Pour RK815DTGL		
2,1m-2,7m (6'11"-8'10")	15m (50')	6m (20')
Pour RK825DTGL:		
1,8m-2,0m (5'11"-6'7")	25m (82')	8m (26')

Remarque: Pour les installations en couloir, sélectionnez la position "L" et appliquez l'option de montage à hauteur de 2,5m/8'2".

3. Réglez les cavaliers (cf. § Réglage des cavaliers).
4. Remplacez le couvercle frontal (en inversant pour cela l'ordre des étapes de la procédure de retrait).
5. Exécutez un test de passage (cf. § Test de passage).
6. **Changement des lentilles** (cf. Figure 2).

Câblage des Terminaux (cf. Figure 5)

Terminal	Description
- 12 +	Entrée 12VCC
ALARM	Relais N.F., 24VCC, 0,1A
TAMPER	Relais N.F., 24VCC, 0,1A

Terminal	Description
FAULT / AM	Non applicable dans cette version.
LED	Contrôle à distance des indicateurs LED Lorsqu'un "Signal d'Activation"*** est appliqué à l'entrée LED du bloc des terminaux ou bornes de connexion, les indicateurs LED se désactivent (cf. aussi l'entrée Test automatique dans le tableau consacré au Réglage des cavaliers). Les voyants LED sont activés si rien n'est relié (sauf si le cavalier LED est éteint (OFF)).

****Signal d'Activation-**
Si une tension de 12VCC est appliquée et que le Cavalier d'entrée LED/SET est en position 12V -Ou-

Si la Terre (GND) est reliée, le Cavalier d'entrée LED/SET est en position 0V.

Réglage des cavaliers

Cavalier	Fonction
SW1-1: LED	Définit le fonctionnement des indicateurs LED du détecteur.
Marche (ON) (Défaut)	L'activation des indicateurs LED dépend du paramétrage du contrôle à distance de leur fonctionnement (cf. § Câblage des Terminaux, borne de connexion LED).
Arrêt (OFF)	Les indicateurs LED sont désactivés.
SW1-2: ACT	Définit si le mode ACT est activé ou non
Marche (ON)	ACT activé. Important! N'utilisez pas le mode ACT™ dans une zone en dehors de laquelle le passage d'objets en mouvement vous paraît logique et attendu, un couloir par exemple.
Arrêt (OFF) (Défaut)	ACT désactivé.

SW1-3: Green Line

RK815DTGL/RK825DTGL comprend une caractéristique 'Green Line', concept qui permet aux détecteurs de respecter les directives environnementales en évitant les émissions excessives.

Marche (ON)
"Green Line" activée: Pour désactiver le module HF pendant les périodes d'inactivité, les indicateurs LED doivent être désactivés à distance.

Arrêt (OFF) (Défaut)
Green Line désactivé (OFF): le canal HF est constamment activé.

SW1-4: Non applicable dans cette version.

J1 - Alarm EOL
J2 - Tamper EOL
Les cavaliers J1, J2 permettent de sélectionner les résistances EOL (fin de ligne) d'Autoprotection, Alarme et FAULT/AM (1K, 2,2K, 4,7K, 5,6K, 6,8K et 12K) en fonction de la centrale (cf. Figure 3 ci-dessous).
Suivez les indications du diagramme de connexion du bloc des terminaux de la Figure 3 pour relier le détecteur à une zone EOL Double (DEOL).

J4 - Entrée LED/SET	Détermine la polarité de l'entrée externe.
	Cf. § Câblage des Terminaux, bornes de connexion LED (Mise en service).
	Cf. § Câblage des Terminaux, bornes de connexion LED (Mise en service).

Test de passage

1. Deux minutes après avoir réalisé la mise sous tension (séquence d'échauffement), effectuez un test de passage pour vérifier l'efficacité du détecteur sur la totalité de la zone à protéger.
2. Assurez-vous d'avoir bien réinstallé le couvercle frontal avant de mettre le détecteur sous tension (cf. Figure 6).
3. Le potentiomètre situé sur la carte PCB permet de régler la portée de détection hyperfréquence. Il est important de régler le potentiomètre sur le niveau le plus bas possible qui fournira cependant une couverture suffisante sur la totalité de la zone à protéger.

Réglage de la portée HF (cf. Figure 4)

1 Trop puissant	A Détecteur
2 Pas assez puissant	B Couloir
3 Réglage correct	



Affichage LED

LED	Position	Signification
Jaune	Allumée (ON)	Détection IRP
	Cignotante	Panne de canal IRP
Verte	Allumée (ON)	Détection HF (hyperfréquence)
	Cignotante	Panne de canal HF
Rouge	Allumée (ON)	Indique une ALARME
Toutes diodes LED	Cignotante ('l'une après l'autre)	Lors de la mise sous tension, les diodes LED cignotent de manière ininterrompue, l'une après l'autre, jusqu'à la fin de la séquence d'échauffement (2 à 3 minutes).

Spécifications techniques

Électriques	
Consommation électrique	14,8 mA à 12VCC (en utilisation typique) 39,5 mA à 12VCC (max. avec tous les voyants LED allumés)
Tension requise	9 -16VCC
Contacts d'alarme	24VCC, 0,1A
Temps minimal de changement d'état:	2,2 seconds
Contacts d'autoprotection	24VCC, 0,1A
Résistance de la boucle de Détection:	Etat ouvert: plus que 10 Etat fermé: moins que 1 ^o ohm
Ondulations résiduelles maximales admissibles:	0,25 crête à crête

Environnementales

Immunité RF	Selon EN50130-4
Température de fonctionnement	De 0°C à 49°C (14°F à 131°F)
Température de stockage	De -20°C à 60°C (-4°F à 140°F)
Indice de protection:	IP 31/IK 02
Taille du câble à utiliser:	Fil de diamètre au moins 0,5 mm pour une longueur ne dépassant pas 300 mètres

Optiques

Filtrage Protection anti-lumière blanche

Physiques

Dimensions	127,6 x 64,2 x 46,6 mm (5 x 2,5 x 1,84 in.)
Poids	120g

Organisme de certification

AFNOR CERTIFICATION: 11 rue Francis de Pressensé 93571 LA PLAINE SAINT-DENIS Cedex, http://www.marque-nf.com
CNPP: BP 2265, 27950 ST MARCEL, http://www.cnpp.com

ESPAÑOL

Los detectores RK815DTGL/RK825DTGL son la última palabra en detectores de movimiento para instalaciones profesionales, incorporando la tecnología Anti-Cloak™ (ACT™), adhiriéndose a las nuevas directrices respetuosas con el medioambiente.

Los detectores RK815DTGL/RK825DTGL están disponibles en versiones de 10m, 15m y 25m, e incluyen resistencias incorporadas de final de línea (EOL para simplificar la instalación).

Instalación / Mantenimiento

1. Montaje - El RK815DTGL/RK825DTGL puede montarse en una superficie plana o en un rincón de pared (montaje en rincón).
 - Usando una herramienta apropiada, abra los siguientes agujeros pre-marcados en la base del detector (ver Figura 1).

Nota: Volver manipulaciones "rompible placa" no se aplica en esta versión.

2. Para seleccionar la posición correcta de ajuste vertical para lentes gran angular utilice la escala en el lado izquierdo del PCB, según se indica:

Altura de montaje y posición de la escala según el tamaño de la habitación:

Altura de Montaje	L - LONG	S - SHORT
Para RK815DTGL		
2.1m-2.7m (6'11"-8'10")	15m (50')	6m (20')
Para RK825DTGL:		
1.8m-2.0m (5'11"-6'7")	25m (50')	8m (26')

Nota: Para instalaciones de Pasillo, seleccione la posición "L" e instale a 2.5m/8'2" de altura.

3. Configure los puentes (véase la sección Configuración de Puentes).

Nota: Reinicie el detector después de que se haga un cambio en las configuraciones.

4. Coloque de nuevo la tapa delantera en su lugar (de modo inverso al de retirarla)
5. Realice una prueba de Movimiento (véase la sección Prueba de Movimiento).
6. **Cambiando las Lentes** (ver Figura 2).

Cableado del Terminal (ver Figura 5)

Terminal	Descripción
- 12 +	Entrada de 12VCC
ALARM	Relé N.C.
TAMPER	Conmutador del Tamper N.C.
FAULT/AM (Fallo/AM)	No se aplica en esta versión.
LED	Control remoto del funcionamiento del LED Cuando se aplica una "Señal de Activación"*** al terminal de entrada del LED, se desactivan todos los LEDs. Los LEDs se activan si no hay nada conectado (a menos que el puente del LED esté en OFF) o se aplican 0V/12V (según la posición del Puente LED/SET Input, 12V ó 0V)

**Señal de Activación-

Si se aplican 12VCC, y el puente (jumper) LED/SET INPUT está en la posición 12V - O -

Se aplican 0V y el puente (jumper) LED/SET INPUT está en la posición 0V.

Configuración de los Puentes

Puente	Función
SW1-1: LED	Usado para determinar el funcionamiento de los LEDs del detector.
ON (Predeterm.)	Los LEDs están habilitados, permitiendo el control del LED a través del terminal de entrada del LED
OFF	Los LEDs están deshabilitados.
SW1-2: ACT	Usado para determinar si el modo ACT está habilitado o deshabilitado
ON</	

ITALIANO

I rivelatori iWISE RK815DTGL/RK825DTGL sono rivelatori di movimento che integrano le tecnologie più avanzate per le installazioni professionali. Questi rivelatori includono la tecnologia (ACT™) e la funzione Green Line per evitare emissioni superflue nell'ambiente.

RK815DTGL/RK825DTGL sono disponibili nei modelli 10, 15 e 25 metri ed hanno le resistenze di fine linea integrate nel circuito per semplificarne al massimo l'installazione.

Installazione / Manutenzione

1. Installazione - RK815DTGL/RK825DTGL può essere installato sia su di una superficie piana che ad angolo.
 - Utilizzando uno strumento appropriato aprire i fori a sfondare, di seguito elencati, della base del contenitore come illustrato in Figura 1.

Nota: Il foro a sfondare per il tamper antirimozione non è applicabile in questa versione.

2. Per selezionare la posizione corretta della scheda elettronica con la lente grandangolo montata, usare i riferimenti (LONG / SHORT) situati nella parte inferiore sinistra della scheda elettronica seguendo le indicazioni della tabella di seguito illustrata:

Altezza di installazione e regolazione scheda elettronica in funzione dell'area di copertura:

Altezza di installazione	L - LONG	S - SHORT
Per il modello RK815DTGL 2.1m - 2.7m	15m	6m
Per il modello RK825DTGL 1.8m - 2.0m	25m	8m

Nota: Per installazioni con Lente Corridoio selezionare sempre la posizione "L" e montare il rivelatore a 2.5m di altezza.

3. Predisporre i ponticelli (Vedere la sezione relativa).

Nota: Ad ogni modifica delle predisposizioni/regolazioni, effettuare sempre un reset del rivelatore rimuovendo e applicando tensione.

4. Rimontare il coperchio frontale e stringere le vite di blocco coperchio.
5. Effettuare una prova di copertura (Sezione Prova di movimento).
6. **Sostituzione delle Lenti** (vedere Figura 2).

Cablaggio Morsetteria (vedere Figura 5)



Morsetto	Descrizione
- 12 +	Ingresso di alimentazione 12V
ALARM	Relé N.C.
TAMPER	Interruttore N.C.
FAULT/AM	Non applicabile in questa versione.
LED	Controllo remoto dei LED e funzione GREEN LINE (con ponticello GREEN LINE inserito) Quando viene applicato un "Segnale di Attivazione"*** al morsetto LED, tutti i LED vengono disabilitati e, se il ponticello GREEN LINE è INSERITO, la sezione microonda viene disabilitata. Nota: affinché la microonda venga disabilitata non ci deve essere alcun comando sul morsetto SET. I LED sono abilitati se al morsetto LED non è collegato niente (a meno che il ponticello LED sia estratto).

**Per Segnale di attivazione si intende quanto segue-

- Viene applicata una tensione 12 Vcc e il ponticello LED/SET Input è nella posizione 12v
- Viene applicato un riferimento di alimentazione 0V e il ponticello LED/SET Input è nella posizione 0V

Predisposizione microinterruttori e ponticelli

Micrint./Pontic.	Funzione
SW1-1: LED	Usato per abilitare o disabilitare il funzionamento dei LED.
ON (Default)	I LED sono abilitati ed è possibile anche controllarli via comando remoto tramite l'ingresso LED.
OFF	I LED sono disabilitati. Non è possibile alcun controllo remoto.
SW1-2: ACT	Usato per abilitare o disabilitare la funzione ACT
ON	ACT abilitato Importante: Non usare la funzione ACT™ se nel luogo di installazione del rivelatore si prevede movimento di oggetti al di fuori dell'area protetta come, ad esempio, il movimento di persone in un corridoio attiguo.
OFF (Default)	ACT disabilitato.
SW1-3: Green Line	RK815DTGL/RK825DTGL include la funzione Green Line che evita emissioni radio superflue nell'ambiente.
ON	La funzione Green Line è abilitata: Per disabilitare la sezione microonda (MW) va applicato un comando di attivazione al morsetto LED (0V o 12V in funzione della polarità configurata tramite il ponticello LED/SET INPUT). I LED verranno in questo caso disabilitati. La sezione microonda viene disabilitata in questo modo solo se al morsetto SET non viene applicata alcuna tensione. Nota: Quando la funzione Green Line è attiva (Microonda spenta), il rivelatore si attiva usando la sola sezione ad infrarossi (PIR).

Micrint./Pontic.	Funzione
OFF (Default)	La funzione Green Line è disabilitata. La sezione a microonda (MW) è sempre accesa.
SW1-4: Self Test	Non applicabile in questa versione.
J1 - Alarm EOL J2 - Tamper EOL	I ponticelli J1 e J2 permettono la selezione dei valori resistivi da assegnare ai circuiti di Tamper e di Allarme (1K, 2.2K, 4.7K, 5.6K, 6.8K) in funzione della centrale d'allarme utilizzata (vedere la Figura 3 in basso). Segue lo schema di collegamento dei morsetti illustrato in Figura 3 quando si vuole collegare il sensore ad una centrale d'allarme usando il doppio bilanciamento resistivo (DEOL).
J4- LED/SET INPUT	Usato per impostare la polarità dei comandi di attivazione per gli ingressi LED e SET.
	Posizionato sul lato 12V richiede come comando di attivazione una tensione positiva. Fare riferimento alla sezione relativa il Cablaggio Morsetteria, morsetto LED.
	Posizionato su 0V richiede come comando di attivazione un riferimento negativo di alimentazione 0V. Fare riferimento alla sezione relativa il Cablaggio Morsetteria, morsetto LED.

Prova di movimento (Walk Test)

1. Due o tre minuti dopo aver alimentato il rivelatore (preriscaldamento) effettuare la prova di copertura dell'area da proteggere verificando la risposta del rivelatore tramite l'accensione dei LED (vedere Figura 6).
2. La portata della microonda va regolata tramite l'apposito potenziometro situato sulla scheda elettronica. Regolare il potenziometro della microonda al minimo possibile riferito all'area da proteggere.

Regolazione Portata MW (vedere Figura 4)

1 Regolazione Alta	A Rivelatore
2 Regolazione Bassa	B Corridoio
3 Regolazione corretta	



LED Stato Descrizione

LED	Stato	Descrizione
Giallo	Illuminato	Rilevazione del canale PIR
	Lampeggiante	Anomalia del canale PIR
Verde	Illuminato	Rilevazione del canale MW
	Lampeggiante	Anomalia del canale MW
Rosso	Illuminato	ALLARME
Tutti i LED	Lampeggiante (consecutivamente)	All'alimentazione tutti i LED lampeggiano in sequenza fino alla fine del periodo di preriscaldamento (2-3 minuti).

Specifiche Tecniche

Elettriche	
Assorbimento di corrente	16mA a 12V - (Nominale) 41mA at 12V - (Massimo)
Alimentazione richiesta	da 9V - a 16V-
Contatti di allarme	24V -, 0.1A
Contatti Tamper	24V -, 0.1A
Ambientali	
Immunità RF	Conforme a EN50130-4
Temp. funzionamento	da 0°C a 49°C
Temp. stoccaggio	da -20°C a 60°C
Ottica	
Filtro	Protezione contro le luci bianche
Fisiche	
Dimensioni	127.6 x 64.2 x 46.6 mm
Peso	120 gr.

PORTUGUÊS

Os detectores RK815DTGL/RK825DTGL são a última palavra em detectores de movimento para instalações profissionais, incorporando a tecnologia Anti-Cloak™ e (ACT™), aderindo às novas normas amistosas do meio-ambiente.

Os detectores RK815DTGL/RK825DTGL estão disponíveis em modelos de 10m, 15m e 25m, e incluem resistências embutidas de fim-de-linha (EOL) para simplificar a instalação.

Instalação / Manutenção

1. Montagem - O iWISE 815DTGL/825DTGL pode ser montado numa superfície plana ou num canto da parede (montagem de canto).
 - Usando uma ferramenta apropriada, abra os seguintes furos pré-marcados na base do detector (ver Figura 1).

Nota: Voltar adulterar "quebrável chapa" não se aplica a esta versão.

2. Para usar a posição correta de ajuste vertical para lentes de ângulo aberto, use a escala localizada no lado esquerdo inferior do PCB, como segue:

Altura de montagem e posição da escala baseada no tamanho do local:

Altura de Montagem	L - LONGA	C - CURTA
Para RK815DTGL 2.1m-2.7m (6'11"-8'10")	15m (50')	6m (20')
Para RK825DTGL 1.8m-2.0m (5'11"-6'7")	25m (82')	8m (26')

Nota: Para instalações de Corredor, selecione a posição "L" e instale a 2.5m/8'2" de altura.

3. Configure os jumpers (ver a seção Configuração de Jumpers).

Nota: Reajuste o detector depois de cada modificação feita nas configurações.

4. Recoloque a tampa dianteira em seu lugar (na seqüência contrária à da remoção)
5. Realize uma prova de Caminhada (ver a seção Prova de Caminhada).
6. Troca de Lentes (ver. Figura 2).

Terminais de Fiação (ver. Figura 5)

Terminal	Descrição
- 12 +	Entrada de 12VDC
ALARME	Relé N.F.
TAMPER	Chave do tamper N.F.
FALHA/AM	Não aplicável nesta versão.
LED	Controle remoto da operação do LED Quando um "Sinal de Acionamento"*** é aplicado ao terminal de entrada do LED, todos os LEDs serão desativados . Os LEDs são ativados se nada estiver conectado (a menos que o jumper do LED esteja em OFF) ou 0V/12V for aplicado (segundo a posição do Jumper de Entrada do LED, 12V ou 0V)

**Sinal de Acionamento-

Se 12VDC é aplicado, e o Jumper de Entrada do LED/SET está na posição 12V

- OU -

oV é aplicado e o Jumper de Entrada do LED/SET está na posição 12V

Configuração dos Jumpers

Jumper	Função
SW1-1: LED	Usado para determinar a operação dos LEDs do detector.
ON (Predeterm.)	LEDs estão habilitados, permitindo o controle do LED através do Terminal de Entrada do LED
OFF	LEDs estão desativados.
SW1-2: ACT	Usado para determinar se o modo ACT está habilitado ou desativado.
ON	ACT Habilitado Importante: Não use o modo ACT™ se pensa que possam existir objetos que se movam fora da área protegida requerida, um corredor por exemplo.
OFF (Predeterm.)	ACT Desativado.

SW1-3: Green Line

O RK815DTGL/RK815DTGL/RK825DTGL inclui uma característica Green Line que segue as diretrizes de proteção ao meio ambiente, evitando a emissão de energia em excesso.

ON

A característica Green Line está habilitada: Para desativar o módulo de microondas quando os LEDs forem desativados remotamente.

Nota: Quando 'Green Line' é ativado (Microondas Desligado), o detector ainda estará funcionando (apenas Infravermelho Passivo).

OFF (Predeterm.)

A característica Green Line está desativada: o Microondas está constantemente em uso

SW1-4: Auto Teste

Não se aplica a esta versão.

J1 - Alarm EOL J2 - Tamper EOL

Os jumpers J1 e J2 permitem a seleção da resistência do Tamper e do Alarme (1K, 2.2K, 4.7K, 5.6K, 6.8K) de acordo com o painel de controle (ver Figura 3 abaixo).

Siga o diagrama de conexão do bloco de terminais na Figura 3, ao conectar o detector a uma Zona de Duplo Fim-de-Linha (DEOL).

J4 - ENTRADA DO LED/SET

Usado para determinar a polaridade da entrada externa.

Ver a seção Terminais de Fiação, terminal LED.

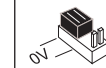
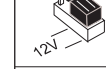

Ver a seção Terminais de Fiação, terminal LED.

Prova de Movimento

Importante: As distâncias podem variar de acordo com as condições térmicas ambientais.

1. Dois minutos depois de ativar (período de aquecimento), caminhe para testar o Detector através de toda a área protegida para verificar a correta operação da unidade (ver Figura 6).
2. O alcance de Microondas deve ser ajustado usando-se o potenciômetro, que está localizado no PCB. É importante colocar o potenciômetro na configuração mais baixa possível que ainda possa proporcionar suficiente cobertura para toda a área protegida.

Ajuste do Alcance do Microondas (ver Figura 4)

1 Energia em excesso	A Detector
2 Energia fraca	B Corredor
3 Ajuste correto	



Visualização dos LEDs

LED	Estado	Descrição
Amarelo	Aceso	Deteção de Infravermelho Passivo
	Piscando	Problema no canal de Infravermelho Passivo
Verde	Aceso	Deteção no Microondas
	Piscando	Problema no canal de Microondas
Vermelho	Aceso	ALARME
Todos os LEDs	Piscando (sucessivamente)	Ao conectar, os LEDs piscarão consecutivamente até o final do período de aquecimento (2-3 minutos). Ao final do período de aquecimento, o LED VERMELHO continuará piscando até o final da iniciação do AM.

Especificações Técnicas

Elétricas	
Consumo de Corrente	16mA a 12VDC (Típico) 41mA a 12VDC (Máx.)
Requisitos de voltagem	9 -16VDC
Contatos de alarme	24VDC, 0.1A
Contatos de Tamper	24VDC, 0.1A
Ambientais	
Imunidade a RF	De acordo com EN50130-4
Temperatura de operação	0°C a 49°C (14°F a 131°F)
Temperatura de armazenamento	-20°C a 60°C (-4°F a 140°F)
Ótica	
Filtragem	Proteção contra luz branca
Físicas	
Tamanho	127.6 x 64.2 x 46.6 mm (5 x 2.5 x 1.84 pol.)
Peso	120 gr. (4.2 oz.)

Standard Limited Product Warranty

RISCO Ltd., its subsidiaries and affiliates ("Risco") guarantee Risco's hardware products to be free from defects in materials and workmanship when used and stored under normal conditions and in accordance with the instructions for use supplied by Risco, for a period of (i) 24 months from the date of connection to the Risco Cloud (for cloud connected products) or (ii) 24 months from production (for other products which are non-cloud connected), as the case may be (each, the "Product Warranty Period" respectively). Contact with customers only. This Product Warranty is solely for the benefit of the customer who purchased the product directly from Risco, or from any authorized distributor of Risco.

Nothing in this Warranty obligates Risco to accept product returns directly from end users that purchased the products for their own use from Risco's customer or from any installer of Risco, or otherwise provide warranty or other services to any such end user. Risco customer shall handle all interactions with its end users in connection with the Warranty, inter alia regarding the Warranty. Risco's customer shall make no warranties, representations, guarantees or statements to its customers or other third parties that suggest that Risco has any warranty or service obligation to, or any contractual privity with, any recipient of a product.

Return Material Authorization. In the event that a material defect in a product shall be discovered and reported during the Product Warranty Period, Risco shall, at its option, and at customer's expense, either: (i) accept return of the defective Product and repair or have repaired the defective Product; or (ii) accept return of the defective Product and provide a replacement product to the customer. The customer must obtain a Return Material Authorization ("RMA") number from Risco prior to returning any Product to Risco. The returned product must be accompanied with a detailed description of the defect discovered ("Defect Description") and must otherwise follow Risco's then-current RMA procedure in connection with any such return. If Risco determines in its reasonable discretion that any Product returned by customer conforms to the applicable warranty ("Non-Defective Products"), Risco will notify the customer of such determination and will return the applicable Product to customer at customer's expense. In addition, Risco may propose and assess customer a charge for testing and examination of Non-Defective Products.

Entire Liability. The repair or replacement of products in accordance with this warranty shall be Risco's entire liability and customer's sole and exclusive remedy in case a material defect in a product shall be discovered and reported as required herein. Risco's obligation and the Warranty are contingent upon the full payment by customer for such Product and upon a proven weekly testing and examination of the product functionality.

Limitations. The Product Warranty is the only warranty made by Risco with respect to the Products. The warranty is not transferable to any third party. To the maximum extent permitted by applicable law, the Product Warranty does not apply and will be void if: (i) the conditions set forth above are not met (including, but not limited to, full payment by customer for the product and a proven weekly testing and examination of the product functionality); (ii) if the Products or any part or component thereof: (a) have been subjected to improper operation or installation; (b) have been subject to neglect, abuse, willful damage, abnormal working conditions, failure to follow Risco's instructions (whether oral or in writing); (c) have been misused, altered, modified or repaired without Risco's written approval or combined with, or installed on products, or equipment of the customer or of any third party; (d) have been damaged by any factor beyond Risco's reasonable control such as, but not limited to, power failure, electric power surges, or unsuitable third party components and the interaction of software therewith or (e) any delay or other failure in performance of the product attributable to any means of communications, provided by any third party service provider (including, but not limited to) GSM interruptions, lack of or internet outage and/or telephony failure.

BATTERIES ARE EXPLICITLY EXCLUDED FROM THE WARRANTY AND RISCO SHALL NOT BE HELD RESPONSIBLE OR LIABLE IN RELATION THERETO, AND THE ONLY WARRANTY APPLICABLE THERETO, IF ANY, IS THE BATTERY MANUFACTURER'S WARRANTY.

Risco makes no other warranty, expressed or implied, and makes no warranty of merchantability or of fitness for any particular purpose. For the sake of good order and avoidance of any doubt:

PALMER. EXCEPT FOR THE WARRANTIES SET FORTH HEREIN, RISCO AND ITS LICENSORS HEREBY DISCLAIM ALL EXPRESS, IMPLIED OR STATUTORY, REPRESENTATIONS, WARRANTIES, GUARANTEES, AND CONDITIONS WITH REGARD TO THE PRODUCTS, INCLUDING BUT NOT LIMITED TO ANY REPRESENTATIONS, WARRANTIES, GUARANTEES, AND CONDITIONS OF MERCHANTABILITY, FITNESS FOR A PARTICULAR PURPOSE, TITLE AND LOSS OF DATA. WITHOUT LIMITING THE GENERALITY OF THE FOREGOING, RISCO AND ITS LICENSORS DO NOT REPRESENT OR WARRANT THAT: (i) THE OPERATION OR USE OF THE PRODUCT WILL BE TIMELY, SECURE, UNINTERRUPTED OR ERROR-FREE; (ii) THAT ANY FILES, CONTENT OR INFORMATION OF ANY KIND THAT MAY BE

ACCESSED THROUGH THE PRODUCT BY CUSTOMER OR END USER SHALL REMAIN SECURED OR NON-DAMAGED. CUSTOMER ACKNOWLEDGES THAT NEITHER RISCO NOR ITS LICENSORS CONTROL THE TRANSFER OF DATA OVER COMMUNICATIONS FACILITIES, INCLUDING THE INTERNET, GSM OR OTHER MEANS OF COMMUNICATIONS AND THAT RISCO'S PRODUCTS MAY BE SUBJECT TO LIMITATIONS, DELAYS, AND OTHER PROBLEMS INHERENT IN THE USE OF SUCH MEANS OF COMMUNICATIONS. RISCO IS NOT RESPONSIBLE FOR ANY DELAYS, DELIVERY FAILURES, OR OTHER DAMAGE RESULTING FROM SUCH PROBLEMS. RISCO WARRANTS THAT ITS PRODUCTS DO NOT, TO THE BEST OF ITS KNOWLEDGE, INFRINGE UPON ANY PATENT, COPYRIGHT, TRADEMARK, TRADE SECRET OR OTHER INTELLECTUAL PROPERTY RIGHT IN ANY EVENT RISCO SHALL NOT BE LIABLE FOR ANY AMOUNTS REPRESENTING LOST REVENUES OR PROFITS, PUNITIVE DAMAGES, OR FOR ANY OTHER INDIRECT, SPECIAL, INCIDENTAL, OR CONSEQUENTIAL DAMAGES, EVEN IF THEY WERE FORESEEABLE OR RISCO HAS BEEN INFORMED OF THEIR POTENTIAL.

Risco does not install or integrate the product in the end user security system and is therefore not responsible for and cannot guarantee the performance of the end user security system which uses the product. Risco does not guarantee that the product will prevent any personal injury or property loss by burglary, robbery, fire or otherwise; or that the product will in all cases provide adequate warning or protection. Customer understands that a correctly installed and maintained alarm may only reduce the risk of burglary, robbery or fire without warning, but is not an assurance or a guarantee that such an event will not occur or that there will be no personal injury or property loss as a result thereof. Consequently Risco shall have no liability for any personal injury, property damage or loss based on a claim that the product fails to give warning. No employee or representative of Risco is authorized to change this warranty in any way or grant any other warranty.

Figure 1. Back cover - Knockouts

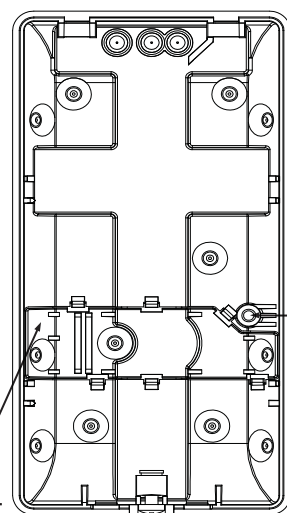

Back tamper "Breakable" plate - Not applicable in this version

Figure 3. Schematic of EOL Resistors Tamper / Alarm EOL Jumpers

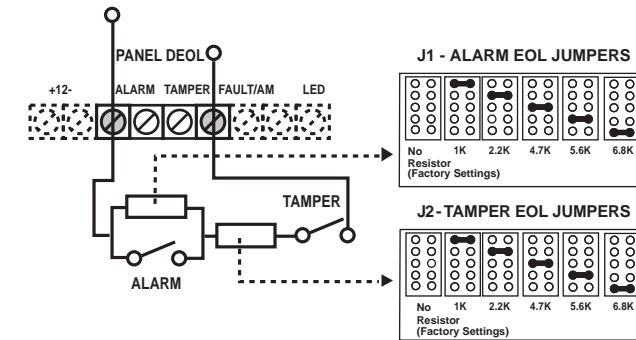
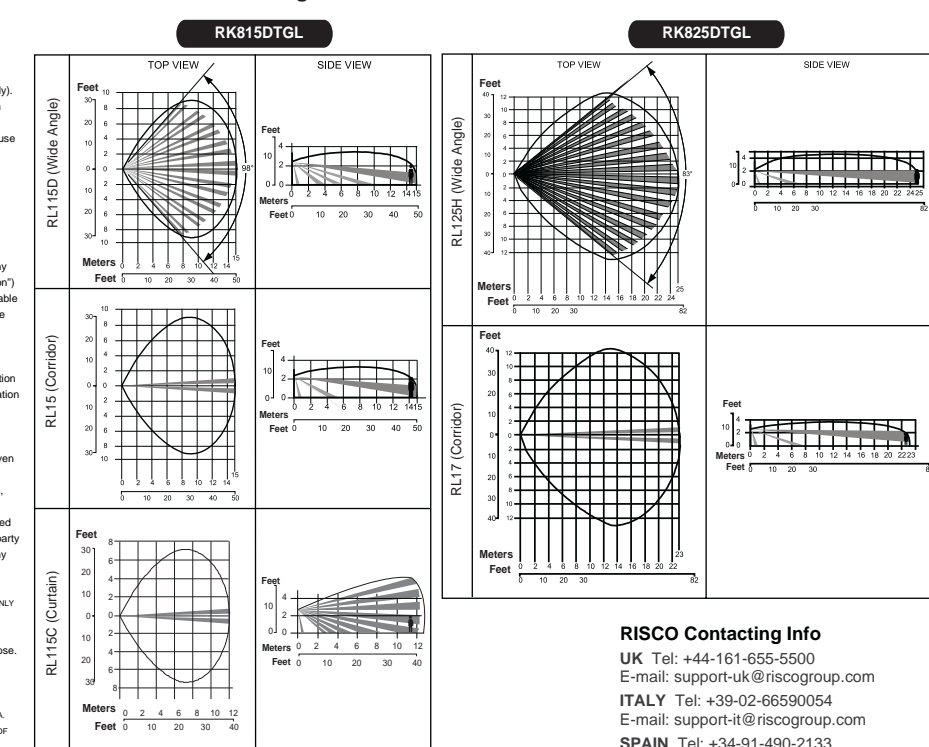

Figure 6. RK815DTGL/RK825DTGL Lenses and Microwave Range



RISCO Contacting Info

UK Tel: +44-161-655-5500

E-mail: support-uk@riscoargroup.com

ITALY Tel: +39-02-66590054

E-mail: support-it@riscoargroup.com

SPAIN Tel: +34-91-490-2133

E-mail: support-es@riscoargroup.com

FRANCE Tel: +33-164-73-28-50

E-mail: support-fr@riscoargroup.com

BELGIUM Tel: +32-2522-7622

E-mail: support-be@riscoargroup.com

U.S.A. Tel: +1-631-719-4400

E-mail: support-usa@riscoargroup.com

CHINA (Shanghai) Tel: +86-21-52-39-0066

E-mail: support-cn@riscoargroup.com

ISRAEL Tel: +972-3-963-7777

E-mail: support@riscoargroup.com