产品规格书

SPECIFICATION

产品名称：微动开关

Product Name: Micro Switch

XV-15-1C25



浙江旭瑞电子有限公司
ZHEJIANG XURUI ELECTRONIC CO.,LTD

1. 特点与用途 Features & Application

- 采用热固性或热塑性塑料外壳

Adopt thermosetting plastic or thermoplastic

- 具有微小触点间隙，动作快速、高灵敏和微小行程

Small contact gap, snap action, high sensitivity and small operating travel

- 配备各种形式的驱动手柄

Variety of levers

- 广泛应用于家用电器、电子设备、自动化设备、通讯设备、汽车电子、仪器仪表等领域

Widely used in appliance, electronic equipment, automatic machine, communication equipment, car electric, apparatus and instrument, electro motion tool etc

2. 型号含义 Model & Meanings

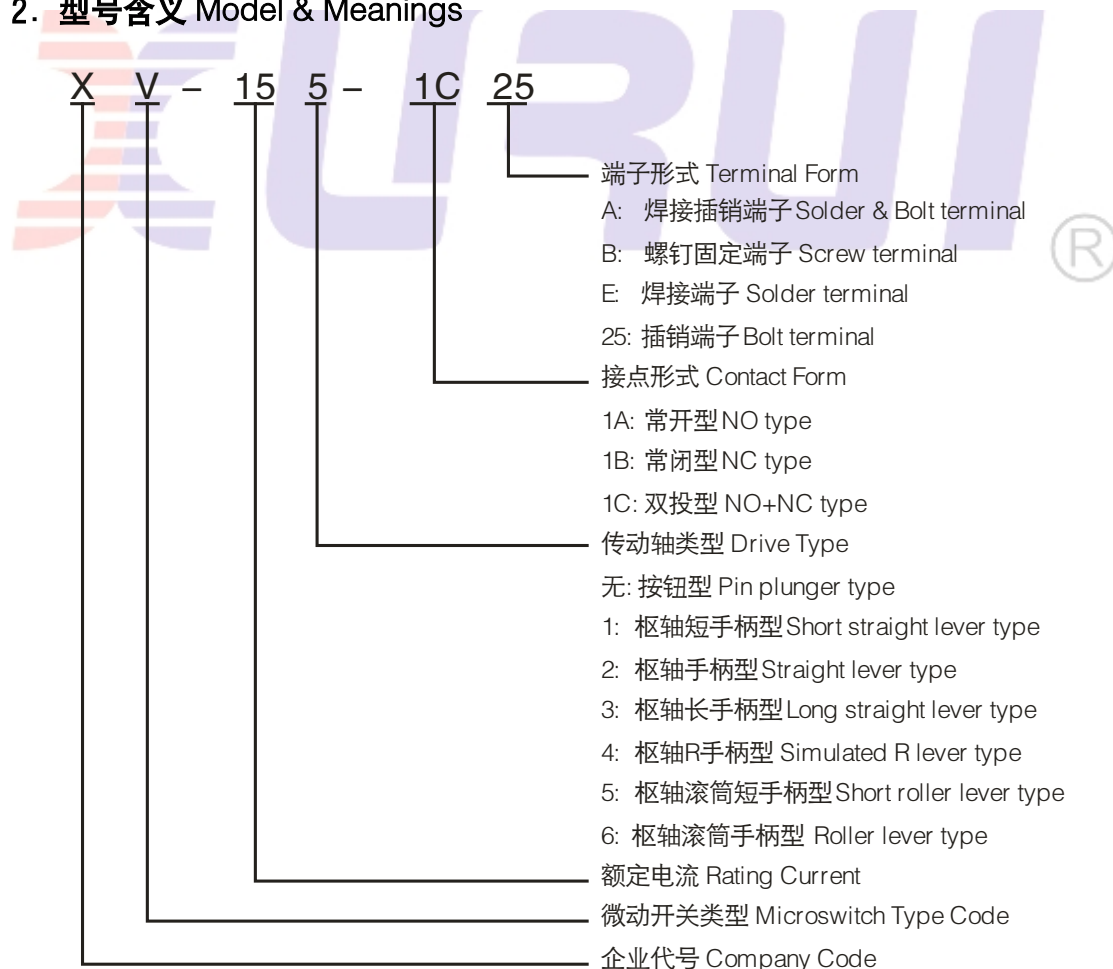

3. 产品图片 Product Photo



4. 外形尺寸图 Dimension

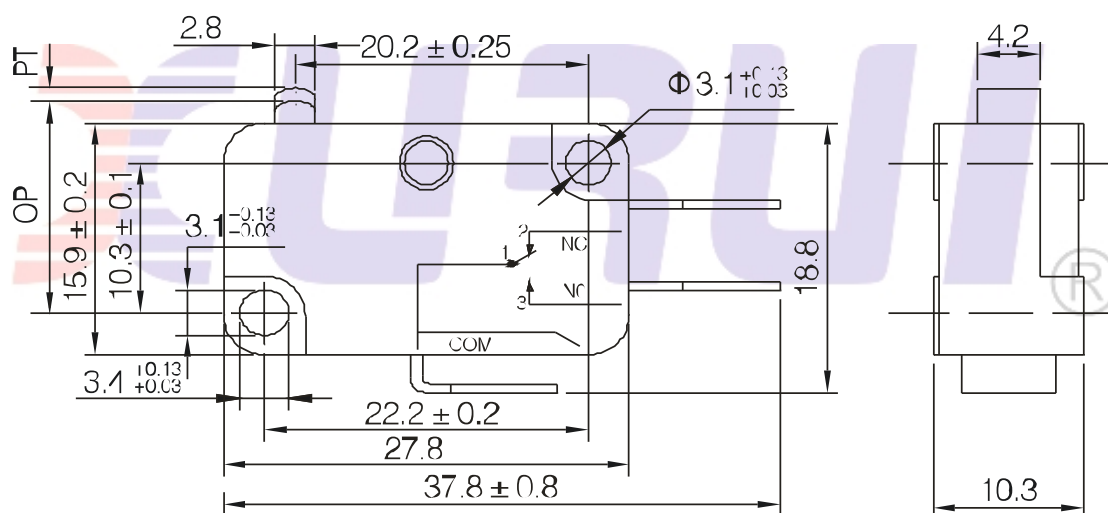

动作力	OF max.	200g(1.96N)
回复力	RF min.	50g(0.49N)
预行程	PT max.	1.2mm
超行程	OT min.	0.6mm
差行程	MD max.	0.3mm
动作位置	OP	14.7 ± 0.6mm

5. 接点形式与安装尺寸 Connection

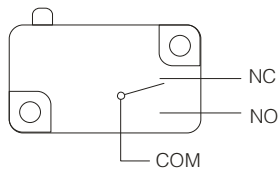

双投型
SPDT(1C)

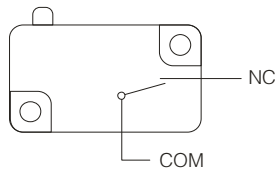

常闭型
SPST-NC(1B)

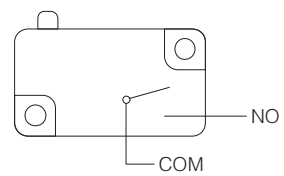

常开型
SPST-NO(1A)

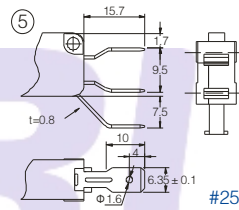
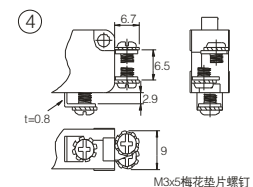
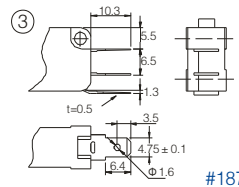
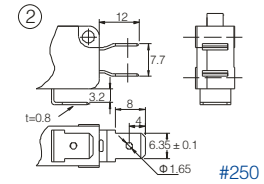
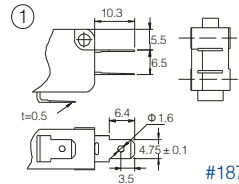
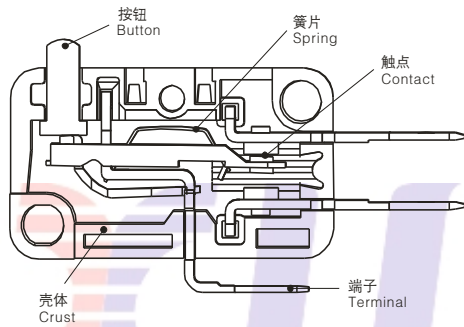
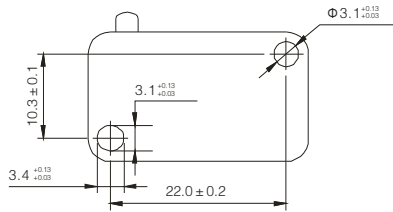

6. 性能参数 Specification

额定电压Ue(V)	额定电流Ie(A)	发热电流Ith(A)
AC-250	7.5	10
AC-125	15	20

项 目 Item	参 数 值 Data	
操作速度 Operating speed	0.1mm-1m/s	
操作频率 Operating frequency	机 械 Mechanical	600次/分 600times/min
	电 气 Electrical	30次/分 30times/min
绝缘电阻 Insulation resistance	100MΩ以上(Above) DC500V	
接触电阻 Contact resistance	25mΩ(初值 initial value)	
介质耐压 Withstand voltage	非 连 线 Non-connection wire	1000VAC
	各端子间 Every terminal	1500VAC
振 动 Vibration	误 动 作 Misoperation	10-55Hz 复振幅 Amplitude 1.5mm
冲 击 Impact	耐 久 Durable	1000m/s ²
	误 动 作 Misoperation	300m/s ²
寿 命 Life	电 气 Electrical	100,000次以上 above
	机 械 Mechanical	1,000,000次以上 above
防护等级 Protection degree	IP40	
使用温度 Operating temperature	-25~+80℃	
使用湿度 Operating humidity	<85%	