



YLI ELECTRONIC

# Fail Safe Electric Bolt W/Signal Time, Open Wire



Model:YB-300

## Parameters

Face Plate	205Lx35Wx41H(mm)
Magnetic Plate	90Lx25Wx2H(mm)
Decorative Panel	215Lx40Wx0.5H(mm)
Bolt	16mmDIA, stainless steel 16mm throw
Signal Output	NO/COM
Time Delay	0/3/6/9 sec
Voltage	12-24VDC
Current	12V/900mA 12V/120mA;24V/730mA 24V/80mA
Fail Safe	Locked when energized
Suitable for	Wooden door, metal door, glass door
Weight	0.7 kg

## Dimensions

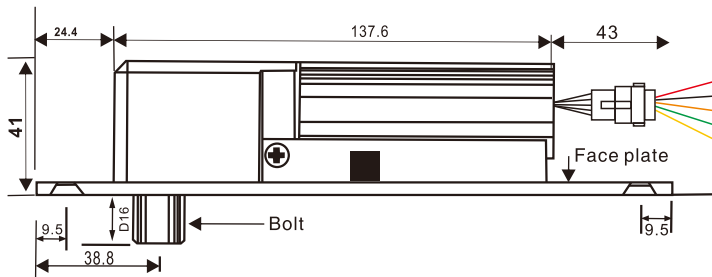

Red	+
Black	-
Orange	OPEN
Green	COM
Yellow	NC

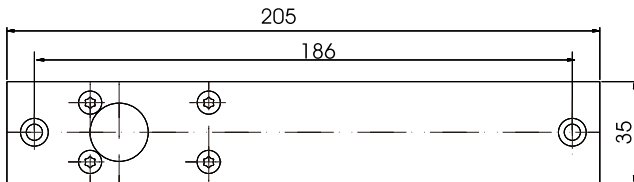

Face plate

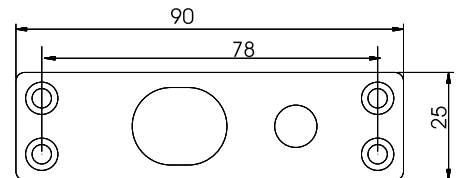

Magnetic Plate

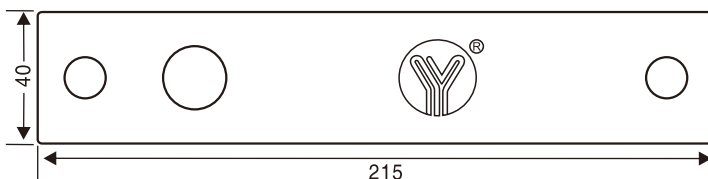

Decorative Plate

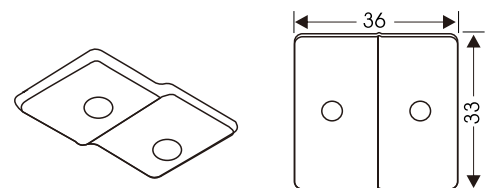

Extended Plate

# Installation

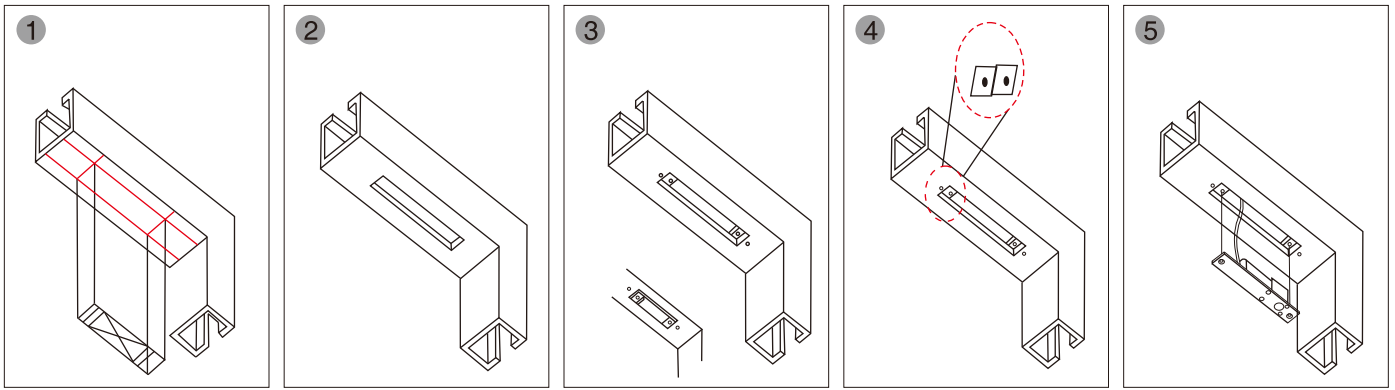

Place lock body template to match with door frame center line

Cut hole

Fix mounting plate (For hollow metal frame)

Connect wires

Mount lock body on the door frame and test

## Installation Instruction

### Frameless Glass Door

Suitable for 10-15mm glass door, BBK-600/601/602 for Frameless Glass Door.

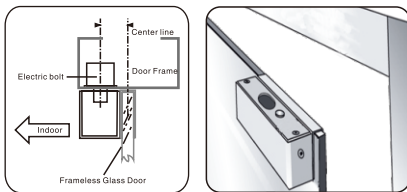

### Fully Frameless Glass Door

BBK-700 for Fully Frameless Glass Door

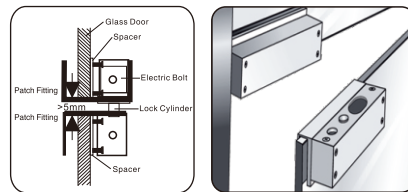

### Aluminium Bracket for Narrow Door

BBK-500 for Narrow Door

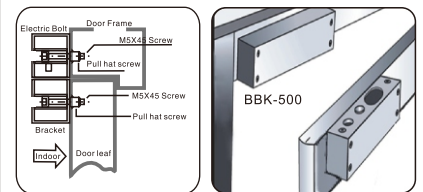

## Wiring Diagram

