

Revision History	
1.0	First formal release.
1.1	1.Update LED current limit resistor default value from 330ohm to 100ohm. 2.Update MOSEFT base resistor value from 10K to 0ohm. 3.Update some test pin name.

Realtek Semiconductor Corp.			
RTL8316D_DEMO			
A4	PLACEMENT		1.1
Thursday, April 29, 2021		1	7

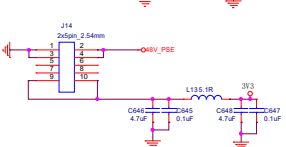

<Title>	
C	<Doc>
Thursday, April 29, 2021	

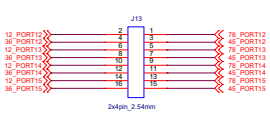
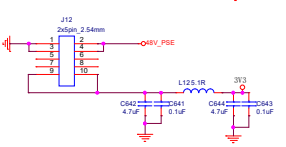
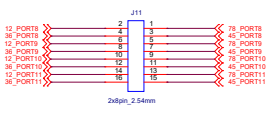
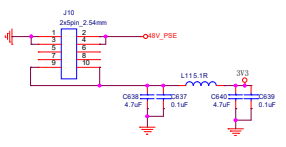
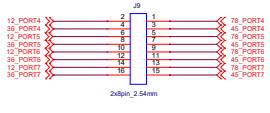
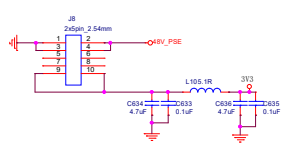
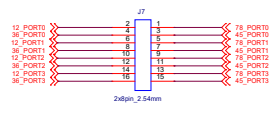
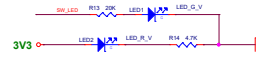
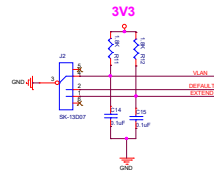
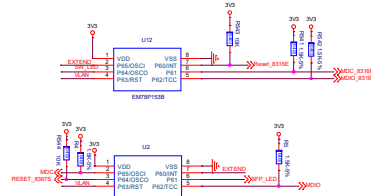
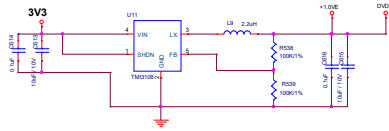
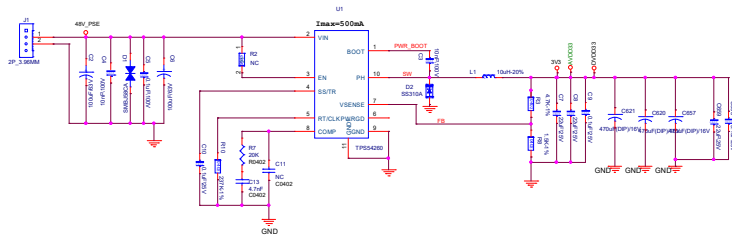



RTL8316D

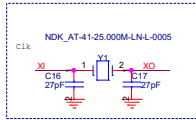

RXIP0	<<	RXIP0	4	TXON8	<<	TXON8	5
RXIN0	<<	RXIN0	4	TXON9	<<	TXON9	5
TXOP0	<<	TXOP0	4	RXIP8	<<	RXIP8	5
TXON0	<<	TXON0	4	TXON9	<<	TXON9	5
TXON1	<<	TXON1	4	RXIP9	<<	RXIP9	5
TXON2	<<	TXON2	4	TXON9	<<	TXON9	5
TXON3	<<	TXON3	4	TXON9	<<	TXON9	5
TXON4	<<	TXON4	4	TXON9	<<	TXON9	5
TXON5	<<	TXON5	4	TXON9	<<	TXON9	5
TXON6	<<	TXON6	4	TXON9	<<	TXON9	5
TXON7	<<	TXON7	4	TXON9	<<	TXON9	5
TXON8	<<	TXON8	4	TXON9	<<	TXON9	5
TXON9	<<	TXON9	4	TXON9	<<	TXON9	5

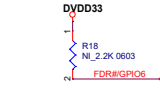
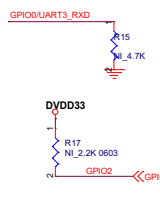
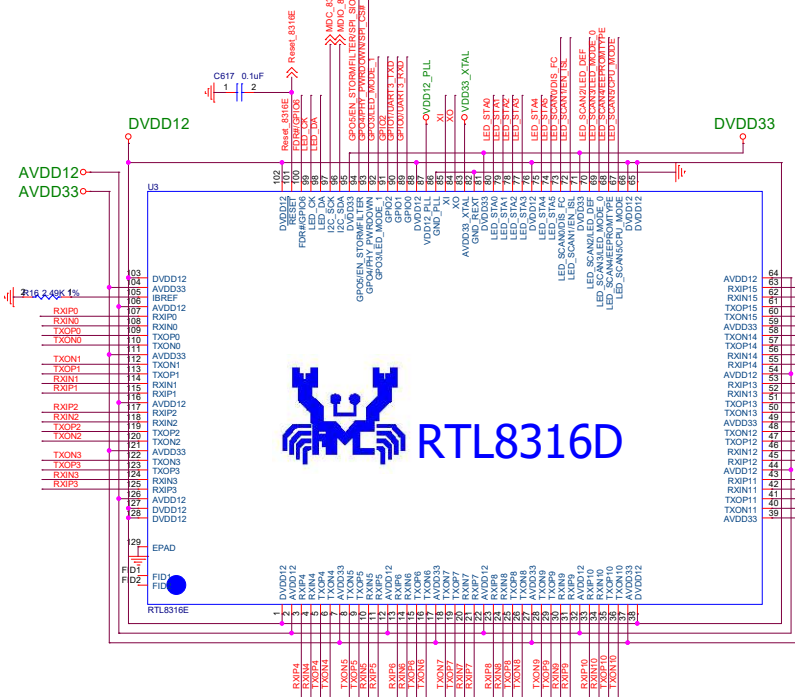

GPIO0/UART3_RXD	<<	GPIO0/UART3_RXD	7
GPIO0/UART3_TXD	<<	GPIO0/UART3_TXD	7
GPIO2	<<	GPIO2	7

LED_CK	<<	LED_CK	7
LED_DA	<<	LED_DA	7

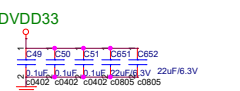
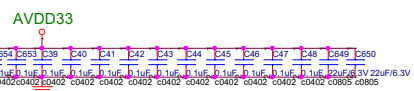
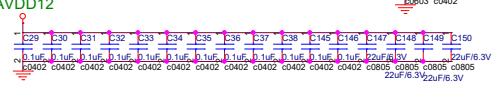
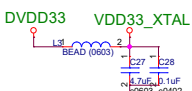
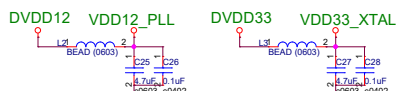
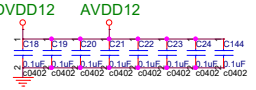
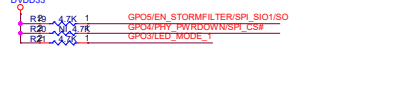

LED_STA0	<<	LED_STA0	6	Scan LED
LED_STA1	<<	LED_STA1	6	
LED_STA2	<<	LED_STA2	6	
LED_STA3	<<	LED_STA3	6	
LED_STA4	<<	LED_STA4	6	
LED_STA5	<<	LED_STA5	6	
LED_SCAN/DIS_FC	<<	LED_SCAN/DIS_FC	6	
LED_SCAN/LED_DEF	<<	LED_SCAN/LED_DEF	6	
LED_SCAN/LED_MODE	<<	LED_SCAN/LED_MODE	6	
LED_SCAN/EEPROMTYPE	<<	LED_SCAN/EEPROMTYPE	6	
LED_SCAN/CPU_MODE	<<	LED_SCAN/CPU_MODE	6	

Realtek Semiconductor Corp.			
RTL8316D_DEMO			
A3	RTL8316D		1.1
Thursday, April 29, 2021			

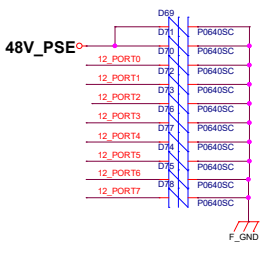
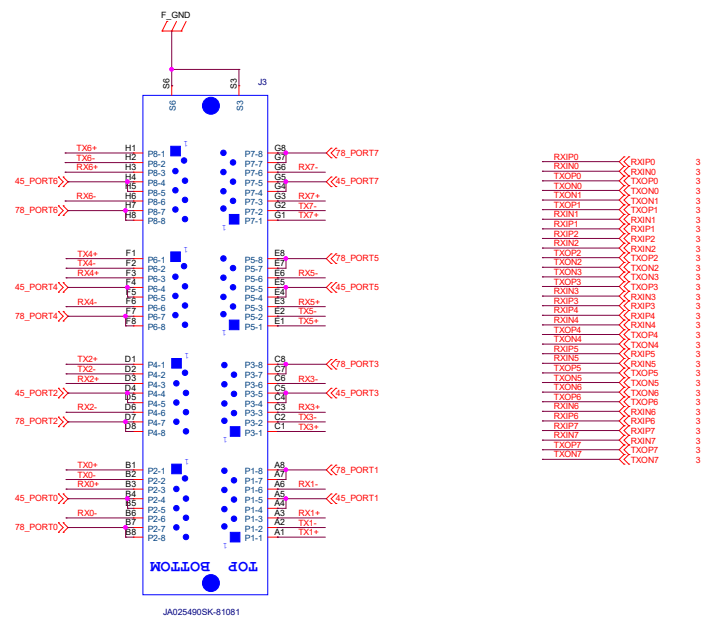
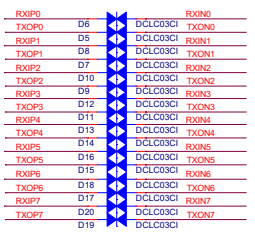
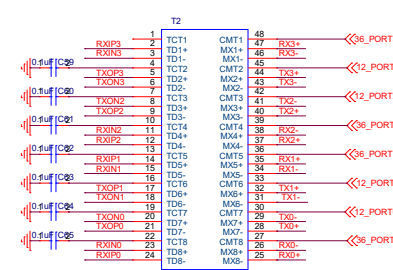
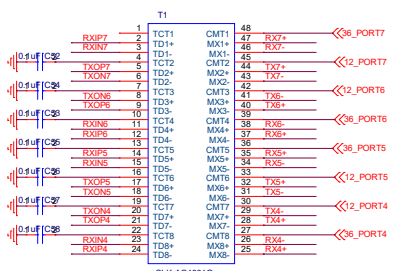

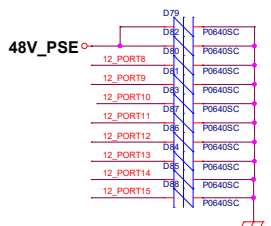
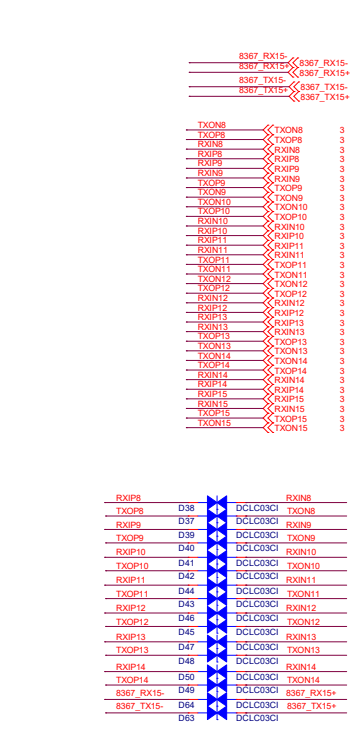
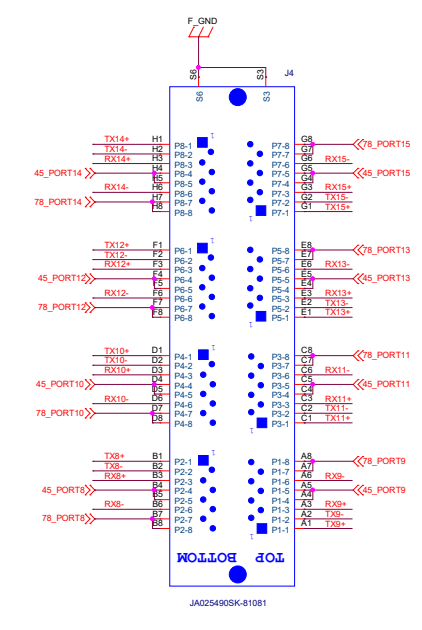
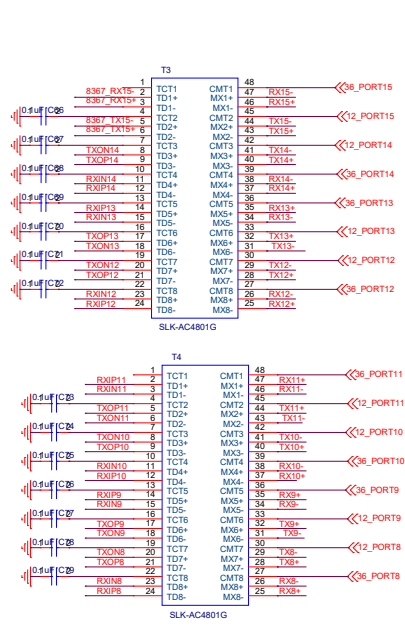

8367_RX15-	8367_RX15+	8367_TX15-	8367_TX15+
TXON8	TXOP8	RXIN8	RXIP8
TXON9	TXOP9	RXIN9	RXIP9
TXON10	TXOP10	RXIN10	RXIP10
TXON11	TXOP11	RXIN11	RXIP11
TXON12	TXOP12	RXIN12	RXIP12
TXON13	TXOP13	RXIN13	RXIP13
TXON14	TXOP14	RXIN14	RXIP14
TXON15	TXOP15	RXIN15	RXIP15

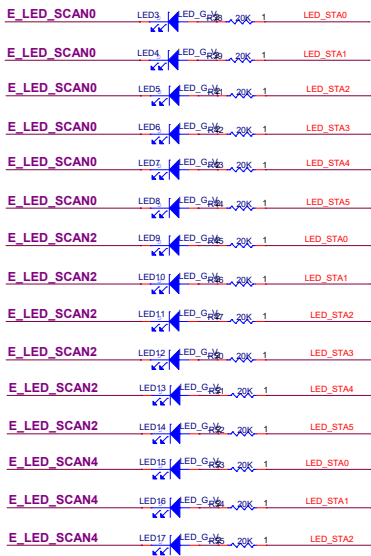
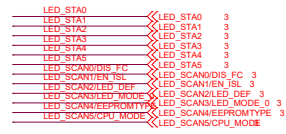

SPD100
LINK/AC

