

# User Manual

## COMMAX CONVERTER UNIT CCU-204AGF

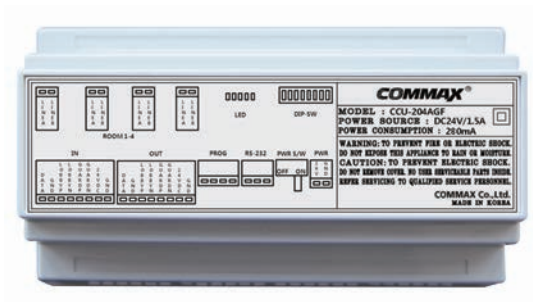

- Thank you for purchasing COMMAX products.
- Please carefully read this User's Guide (in particular, precautions for safety) before using a product and follow instructions to use a product exactly.
- The company is not responsible for any safety accidents caused by abnormal operation of the product.



# Table of Contents

1. Feature .....	1
2. Warnings and caution.....	2
3. The name & Function .....	4
4. Manual to use.....	5
5. System Diagram.....	9
6. wiring.....	10
7. Precautions. ....	11
8. Others.....	11
9. Specifications and Characteristics .....	11











## 1. Feature

- This unit as a 4-channel distributor for the layer 1 POWER is available to a maximum of three.(within 30 meters.)
- This unit can be used by connecting with the 2-wire loop type Interphone (ex. AP-2SAG) manufactured in COMMAX.
- This unit connect with a lobby phone in 6wires & connect with a distributors in 8wires.
- Remote updating is possible by guard phone.
- Please make sure to check the wire sequence.
- Avoid duplication other devices ID.
- When use a Power Adapter of COMMAX : RF-24AS
- When use a Power Adapter of other venders: DC24V/3A













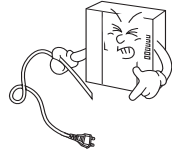



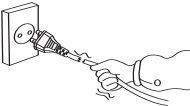

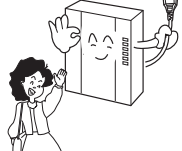

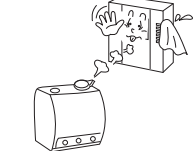

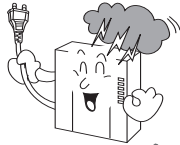

## 2. Warnings and caution

Please follow the things described below in order to prevent any danger or property damage.

 <p><b>Warning</b> It may cause a serious damage or injury if violated.</p>  <p><b>Caution</b> It may cause a minor damage or injury if violated.</p>	 Prohibition.  No disassembly  No touch  Must follow strictly.  Shows plugging out the power cord without an exception  Shows the warning and caution for an electric shock.  Shows the warning and caution for a fire.
---	--

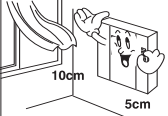
### Warning

<b>Power &amp; Installation</b>	<p>Please don't use several products at the same time on one power socket. · It may cause a fire due to an abnormal overheating.</p>    <p>Prohibition Fire</p>	<p>Please don't bend the power cable excessively or it may cause an electric shock. · fire when using a damaged power cable.</p>     <p>Prohibition Electric Shock Fire</p>	<p>Please don't handle the power cable with a wet hand. · It may cause an electric shock.</p>    <p>Prohibition Fire</p>	<p>Please plug out the power cable from the socket when not using it for a long period of time. · It may shorten the product lifespan or cause a fire.</p>    <p>Demand Fire</p>
	<p>Please don't install the product in the place where there is much oil, smoke or humidity. · It may cause an electric shock or fire.</p>     <p>Prohibition Electric Shock Fire</p>	<p>Please don't install the product with the lightning and thunder. · It may cause an electric shock or fire.</p>     <p>Prohibition Electric Shock Fire</p>	<p>Please don't use and connect this product with other products with different rated voltage · It may cause a disorder or fire.</p>    <p>Prohibition Fire</p>	<p>When installing the product that generates heat, please install the product away from the wall (10cm) for the ventilation. · It may cause a fire due to the increased internal temperature.</p>    <p>Prohibition Fire</p>

## ! Warning

### Cleaning & Use

Please don't disassemble, repair or rebuild this product arbitrarily (please contact the service center if a repair is needed).

- It may cause an electric shock or fire.



If an abnormal sound, burning smell or smoke is coming out of the product, please plug out the power cable and contact a service center.

- It may cause an electric shock or fire.



Please don't insert any metallic or burnable materials into the ventilation hole.

- It may cause an electric shock or fire.

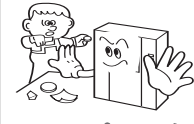

Please use only the designated batteries for the products of using DC power.

- It may cause an electric shock or fire.

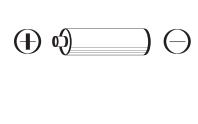

## ! Caution

### Power & Installation

Please plug the power cable firmly into the inner end

- It may cause a fire.

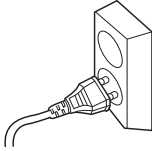

Please hold the plug tightly when unplugging the power cable (a part of the copper wire may be disconnected if the grabbing is only made on the cord when pulling out the cable).

- It may cause an electric shock or fire



When connecting the power cables after cutting the cable, please install the product with power off

- It may cause an electric shock or fire



When installing the product, please fix it firmly while using the wall-mounting unit and screws.

- It may cause an injury from the falling object.

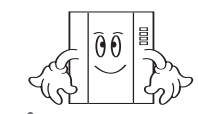

Please be careful when using an AC circuit breaker since there is a possibility of an electric shock.

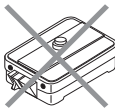

Please check the use voltage and current for the DC-only products and use the appropriate rectifier.

- It may cause a fire.



Please avoid direct rays of the sun or heating devices at a time of installation.

- It may cause a fire.

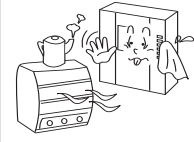

Please don't install the product on an unstable place or small support board.

- It may cause an injury if it falls down while in use.



### Cleaning & Use

When cleaning the product, please rub it with a soft and dry cloth after plugging out the power cable. (Please don't use any chemical products such as wax, benzene, alcohol or cleanser.)



Please don't drop the product on the ground and don't apply a shock.

- It may cause a failure.

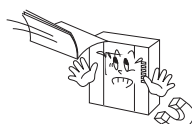

Please use the designated connection cable within the maximum calling distance designated for the product

- It may reduce the product performance.





### 3. The name & Function

#### 3-1. Draft & Table Name

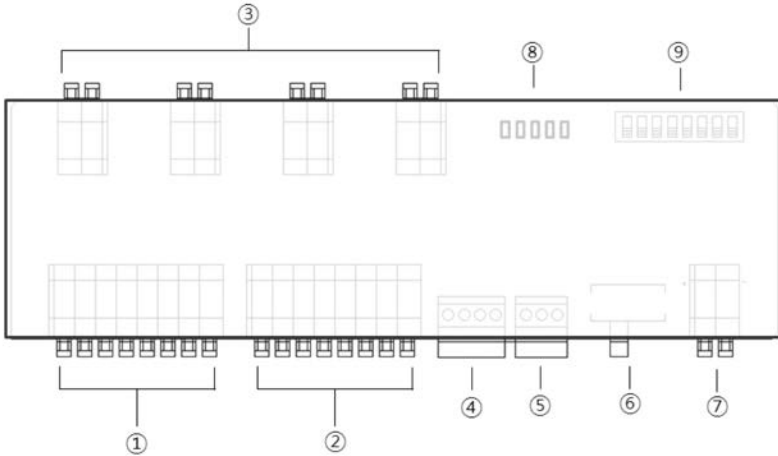

No.	Part	No.	Part
1	Common line output	6	POWER SWITCH
2	Common line input	7	Power Input Terminal
3	Household input & output	8	STATUS LED
4	Program terminal	9	ID SWITCH
5	RS-232 terminal		

#### 3-2. FUNCTION

- ① Common line output terminal : Distributor Common line output terminal
- ② Common line input terminal :  
Lobby Common line & Distributor common line input terminal
- ③ Household in& output terminal: house hold call line input terminal.
- ④ Program terminal : This product is a terminal for program download.
- ⑤ RS-232 Connection terminal : you can use it If you change settings by a PC.
- ⑥ Power switch : ON/OFF SWITCH FOR POWER.
- ⑦ Power input terminal : RF-24AS Adaptor connection terminal.
- ⑧ Status LED : LED is on depending to the status.
  - 1) Power LED: The LED is on when the power is on.
  - 2) Lobby call LED : The LED is on when calling between HOUSEHOLD & LOBBY.
  - 3) Guard call LED : The LED is on when calling between Household & Guard or House hold.
  - 4) Data LED : The LED is on when transferring data between devices.
  - 5) Error check LED : The LED is on when Error.
- ⑨ The Switch to set up the ID : This is The DIP SWITCH to set the ID.



## 4. Manual to use

### 4-1. Door open function of the Lobby (Control function of household interphone)

- Pls. proceed as follows if you want to open the door with the interphone while talking to Lobby phone.

4-1-1 : Method using the Hook switch

(1) Press & release the hook switch for 1 seconds.

(2) This opens the door.

(3) Pls. down the handset To end the call.

(Caution: Guard room is called if you do not hang up in a period time)

4-1-2 : The way to use the button for opening a door.

(if you have a door open button in a household.)

(1) Press the door open button while talking to the lobby.

(2) Door is opened.

(3) Pls. down the handset To end the call.

### 4-2. When changed by the guard phone :

refer to the use manual of linkage guard phone







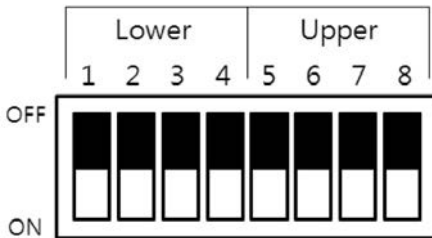



### 4-3 The Method to set the device ID

You should set the device ID up BCD code using DIP switch.

1) DIP switch is divided into two parts, Lower 4 bits(1~4) and Upper 4 bits(5~8)

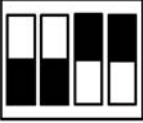

- 2) Lower bits are set up unit's place and Upper are ten's place.  
 - You can set up to 99 IDs maximally.

Number	How to set up	Number	How to set up
0	OFF  ON	5	OFF  ON
1	OFF  ON	6	OFF  ON
2	OFF  ON	7	OFF  ON
3	OFF  ON	8	OFF  ON
4	OFF  ON	9	OFF  ON

# 5. System Diagram

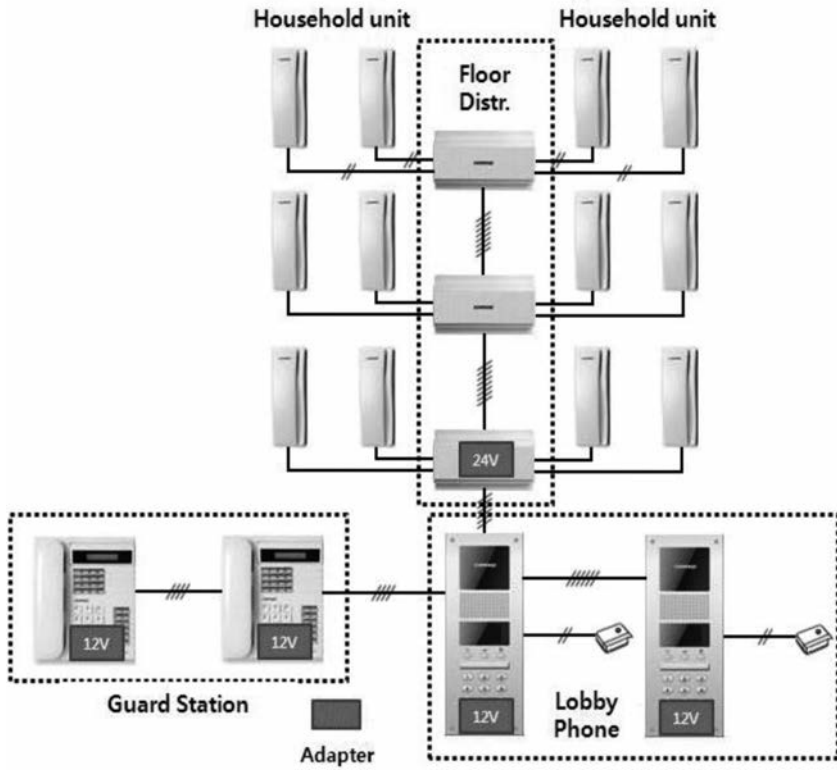





# 6. wiring

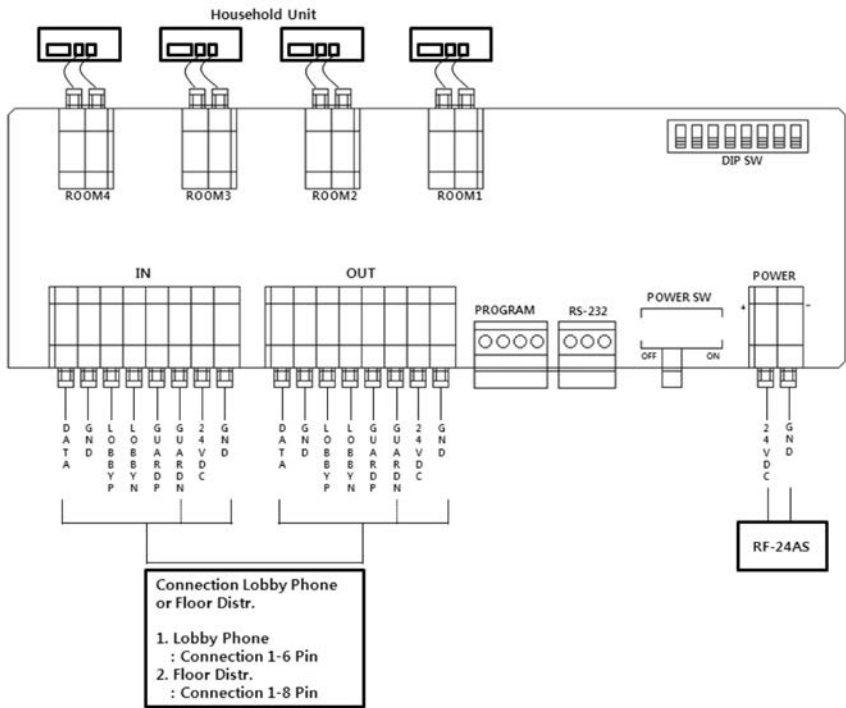



## 7. Precautions.

- The product is damaged or if an error occurs, please contact directly to customer support team in headoffice.
- Do not place a flower vase or bottle on the product.
- A proper cutoff( the device can cut all) must be used Indoor wiring in a building when risk of fire or equipment occurs, press down the breaker of the building as soon as possible.
- First of all, off the power & install the unit or repair the product.



## 8. Others

- Before making a call for a faulty equipment, please read the manual thoroughly.
- Please check all status prior to making a customer service call.



## 9. Specifications and Characteristics

Model	CCU-204AGF
Wiring	To Lobby 6 Common Wires, To Floor Distributer 8 Common Wires
Power	24V $\overline{\text{---}}$ / 1.5A
Power consumption	Standby : 210mA
	Maximum : 280mA
Range	200 meter / $\phi \pm 0.65\text{mm}$ wire
	Household $\leftrightarrow$ CCU-204AGF $\leftrightarrow$ Guard

# **COMMAX**

**COMMAX Co.,Ltd.**

513-11, Sangdaewon-dong, Jungwon-gu, Seongnam-si, Gyeonggi-do, Korea

Int'l Business Dept. Tel. : +82-31-7393-540~550 Fax. : +82-31-745-2133

Web site : [www.commax.com](http://www.commax.com)

PM32204AGF10

Printed In Korea / 2014.10.104